

INSTRUCTION & REFERENCE MANUAL

Fuego

*The Cone 10 High Fire
40 Litre (1.4 cu ft) kiln that
plugs into a 230 volt 13 amp
home circuit*



The Robbin

*The Low Fire 70 Litre (2.5 cu ft)
kiln that plugs into a 230 volt 13
amp home circuit.*

FOR PARTS AND SERVICE CONTACT POTCLAYS LTD

Potclays Ltd

**Brickkiln Lane, Etruria
Stoke-on-Trent
Staffordshire ST4 7BP**

Phone: 01782 219816

Fax: 01782 286506

Email: sales@potclays.co.uk

Web: www.potclays.co.uk



IMPORTANT CAUTIONS

INSTALLATION CAUTIONS

AMBIENT TEMPERATURES

Operate in an environment between 0°C and 38°C (32 - 100°F).

CLEARANCES

Install kiln a minimum of 30 cm (12") away from any wall, although a minimum of 45 cm (18") is preferable. Maintain a minimum of 90 cm (36") between two adjacent kilns especially if they are going to be used at the same time.

YOU MUST USE THE SUPPLIED KILN STAND

Never set a kiln on a floor without significant air space circulating under the kiln. This is part of the insulation system of the kiln. Level the stand while installing.

WALL AND FLOOR MATERIALS

Walls and floors must be non-combustible. Recommended floor surfaces are cement, ceramic tile, stone, slate, breeze blocks or brick. Do not install on a wood floor or on carpet. Vinyl flooring may also be combustible. Protect linoleum flooring from discoloration with a non-combustible covering. Remember that the kiln radiates heat over a long period of time and that this could start a fire under certain conditions. The continued heat of the kiln can dry out combustible surfaces over time and lower the temperature at which they could start burning. Temperatures at combustible ceilings and floors should be kept below 70°C (160°F). Check temperatures around the kiln while firing.

REQUIRED VENTILATION FOR THE KILN

It is important to vent the room that the kiln is operating in. Kilns generate harmful fumes and heat when firing ceramics. Fumes can include carbon monoxide, formaldehyde, sulphur dioxide, heavy metal vapours, and fluorides (all of which can be very toxic). Install kiln in a well-ventilated area. Never operate in an enclosed space (such as a closet) without proper ventilation. The heat in an enclosed room could present a significant fire hazard. Severe corrosion can be caused by kiln fumes, salt air or other environmental conditions. Ventilation must be to the outside (and not under a window).

USE COPPER WIRE FOR HOOK UP

Do not use aluminum wire.

PROTECT POWER LEAD FROM KILN CASE

Route Power Lead away from kiln in such a way that it cannot touch the hot case of the kiln. Secure wires so they cannot move.

KEEP KILN DRY & IN PROTECTED SPACE

The kiln must be kept dry. Water in contact with a kiln can cause an electrocution hazard.

FIRE EXTINGUISHER

Keep an adequate fire extinguisher (rated for electrical fires) near the kiln and check it yearly or according to local codes

THE L&L FUEGO OR ROBIN KILN INSTRUCTIONS (EUROPEAN VERSION)

GENERAL ENVIRONMENT CAUTIONS

SURFACE IS HOT AND CAN CAUSE BURNS

Kiln surface can be extremely hot (up to 260°C/ 500°F) and can cause severe burns if touched.

KEEP CHILDREN & ANIMALS AWAY FROM KILN

Protect children, animals, and unqualified adults from the kiln.

KEEP FLAMMABLES AWAY FROM KILN

Avoid flammable or loose clothing around kiln.

PRE-FIRING CAUTIONS

PROPER USE OF KILN WASH

Make sure the floor of the kiln and the tops of the shelves are coated with kiln wash. This will protect these surfaces from melting glaze and ceramics. Do not coat the undersides or sides of the shelves. Do not apply kiln wash to the brick sides or element holders.

DO NOT USE SILICA SAND IN KILN

Silica can damage the kiln elements.

NEVER FIRE MOIST GREENWARE

We recommend using Preheat in your bisque programme to help dry out any moisture that you cannot see.

LOADING & UNLOADING CAUTIONS

UNPLUG KILN WHEN NOT IN USE

KEEP LID CLOSED WHEN KILN IS NOT IN USE

Do not store anything on the closed lid or in the kiln.

DO NOT OPEN THE LID WHEN KILN IS ABOVE 120°C (250°F)

FIRING CAUTIONS

DON'T FIRE KILN ABOVE Cone 10 (1290°C, 2350°F)

Note that the The Robin Kiln is rated to Cone 02 (1100°C, 2012°F).

ATTEND THE FIRING

No automatic safety device is foolproof! Be especially careful about attending the kiln while it is supposed to shut off. You can plan your firing using the Delay feature. If you can not be at the kiln all the time be sure to attend the end of the firing.

USE PROGRAMME REVIEW

Review the current programme prior to starting the kiln to ensure the correct profile is programmed. This is done by pressing the Review Prog button.

THE L&L FUEGO OR ROBIN KILN INSTRUCTIONS (EUROPEAN VERSION)

USE THE PROPER THERMOCOUPLE

Never use a different type of thermocouple with your controller unless it has been set up from the factory. Use of a type S thermocouple will over fire your kiln. The standard thermocouples that come with the Fuego and The Robin kilns are type K.

USE WITH THE THERMOCOUPLE PROTECTION TUBE

Note that the control has been programmed with a 10°C thermocouple offset to compensate for the effect of the ceramic thermocouple protection tube. If for some reason you were to use the kiln without that protection tube the control would fire 10°C colder.

USE CAUTION WHEN VIEWING INTO THE KILN

Use dark glasses (shade number 1.7 to 3.0) to view inside the kiln through the peepholes when firing. These will protect you from the radiant infrared radiation and will also protect your eyes in case the ceramic ware explodes. Do not use regular sunglasses for this.

USE CAUTION WHEN OPENING THE KILN

- 1) Use heat resistant gloves when opening peephole plugs.
- 2) Use heat resistant gloves when opening a hot lid.
- 3) Do not open the lid when kiln is above 120°C (250°F).

POST FIRING CAUTIONS

CHECK FOR GLAZE AND CERAMIC CHIPS

Remove any glaze that has splattered on the firebrick or shelves. (Use safety glasses when doing this because glaze can be sharp like broken glass). Vacuum the kiln after each firing.

GENERAL MAINTENANCE CAUTIONS

ELECTRICAL SAFETY

Unplug kiln when servicing it. The elements carry high voltage when switched on and could electrocute you. Troubleshooting tests performed under power should ONLY be done by a licensed electrician.

THE WRONG PARTS CAN BE HAZARDOUS

Off-brand elements, if not designed properly, can present a hazard to the kiln (by drawing too much amperage). The wrong type of fuse, relay, switch or other component can cause a fire or other hazardous condition. An improperly rated lead can cause a fire. Do not substitute or replace any parts with unauthorized products.

KILN MODIFICATIONS

All customer modification is made solely at the risk of the customer. Modifications will void the warranty. L&L takes no responsibility for hazardous conditions created by unauthorized modifications. Any authorization for an engineering change must be in writing from the factory.

KILN MAINTENANCE

See the section at the end of this booklet on periodic maintenance you need to perform on your kiln.

OPERATION

HOW YOUR FUEGO OR THE ROBIN KILN WORKS

The automatic program control measures the temperature inside the kiln using the thermocouple probe. The control automatically adjusts power to evenly heat up the kiln according to one of the four programs you are firing. You do not typically have to adjust anything once you start firing. However, if you are manually venting the kiln by opening the top vent hole you will have to manually close this at the appropriate point in the program (typically about 500°C / 932°F).

DIFFERENCES BETWEEN FUEGO AND THE ROBIN KILN

Both the Fuego and The Robin use the same control system and the same elements and power supply. The Fuego is capable of reaching cone 10 temperatures (approximately 1290°C / 2350°F). The Robin is capable of reaching cone 02 temperatures (approximately 1100°F / 2012°F) because it is heating a larger chamber with the same power.

USING YOUR FUEGO OR THE ROBIN KILN

TURNING ON THE KILN

- 1) Make sure your circuit breaker or fused disconnect switch is turned on.
- 2) Make sure the kiln is plugged in.
- 3) Turn on kiln with the toggle On/Off switch on the front of the control box.

WHEN YOU FIRST TURN ON THE KILN

- 1) When the kiln is turned on you will see either **Err P** or **StOP** in the display. If you see **Err P** press any key to see **StOP**. When you see **StOP** or **IdLE** alternating with the temperature you are ready to begin programming. (NOTE: If the power was on recently the display might read what it said before power was turned off).
- 2) Press **ENTER** to begin.
- 3) The previously fired program will be displayed, either **USr 1**, **USr 2**, **USr 3**, or **USr 4**.
- 4) If you want to review that program hit the **DOWN** (Review) button.
- 5) If you want to fire that program hit **ENTER** and keep hitting **ENTER** to scroll through the program. At the end of the program you will see **rEd I**. Hit **ENTER** again to start the program.
- 6) If you make a mistake just hit **ENTER** again to **StOP** the program. (You can stop the program from firing at any time by doing this). This will return you to the **IdLE** alternating with temperature. Hit **ENTER** again to display the program you are in. You can then change the program (see "Editing a Program" below) or can hit **ENTER** again and review and edit the program you are in.

WHAT YOU SEE WHILE FIRING

- 1) If you have a Delay Time programmed you will see **dLAY** alternating with a time (i.e. **00.30**). This will count down until it hits **00.00**.
- 2) Then the display will show you the actual temperature inside the kiln as it begins to fire.

THE L&L FUEGO OR ROBIN KILN INSTRUCTIONS (EUROPEAN VERSION)

TO CHANGE TO A DIFFERENT PROGRAM

- 1) Select the program to change or fire with: When the display reads **IdLE** alternating with temperature hit **ENTER**. One of the four **USr** programs will display. Use the **UP** and **DOWN** arrows to scroll to the program you want to change.
- 2) Hit **ENTER** and you will scroll through that program. If you don't want to make any changes just keep hitting **ENTER** until **rEdI** displays. You must go through the entire program. You can make changes while you are doing this if you want (see "Editing a Program" below). This is actually a good way to review the program before firing. You cannot bypass this process. Once **rEdI** displays and you hit **ENTER** the program will fire.
- 3) **NOTE:** If the Display reads **rEdI** and you do not want to fire the program that the control is ready to fire then hit **ENTER** once to start that program and then again to **StOP** it. The display will then read **StOP** briefly and then alternate between **IdLE** and temperature and you can now choose a different program to run or edit.

EDITING A PROGRAM

- 1) The Delay Time will delay the start of your firing. **ENTER** a Delay Time: **dELA** is displayed alternating with a time like **03.00** (Hours. Minutes). Use the **UP** and **DOWN** keys to change the delay time. Press **ENTER** when the desired delay time is displayed. Note: **00.00** equals no delay. **NOTE: The delay time is like a countdown timer - it will countdown the hours and minutes after you start the program before the program actually sends heat to the kiln.**
- 2) **ENTER** the number of segments your program will have. **NOTE:** Each segment consists of a ramp rate, a set point temperature and a hold time. There are 8 segments available for programming. You will see **SEG** alternating with the last selected number of segments. Use the **UP** and **DOWN** keys to select the number of segments, then press **ENTER**. Note that you can have as little as one segment (for instance a program that makes the kiln go as fast as possible to a single temperature and then holds there).
- 3) Now program the ramp rate for the first segment. You will see **rA 1** alternating with the ramp rate. Ramp rates are expressed in degrees per hour. Use the **UP** and **DOWN** keys to select the desired rate and press **ENTER**. A rate of **9999** will cause the kiln to heat (or cool if in a down ramp) as fast as the kiln is capable of. The first segment of a program must always be an "up" ramp.
- 4) Now program what Temperature to reach at the end of the first segment. You will see **°C 1** alternating with the currently selected temperature. Use the **UP** and **DOWN** keys to select the desired temperature and press **ENTER**.
- 5) Now program the Hold Time for the first segment. You will see **HLd1** alternating with the currently selected hold time. Use the **UP** and **DOWN** keys to select the desired hold time and press **ENTER**.

NOTE: These programs are pre-programmed:

USr 1 is a slow bisque fire to 1015°C.

USr 2 is a fast bisque fire to 1020°C.

USr 3 is a slow glaze fire to 1180°C.

USr 4 is unprogrammed.

All of the above can easily be changed.

THE L&L FUEGO OR ROBIN KILN INSTRUCTIONS (EUROPEAN VERSION)

IMPORTANT NOTE ABOUT HOLD TIMES DURING THE LAST SEGMENT: Be careful with hold times in the final segment of a program designed for ceramics - this will add to the heat work and will typically mean you need to fire to a lower temperature to get the same cone result.

- 6) Repeat the above three steps for each additional segment for the ramp rate, temperature, and hold time.
- 7) **rEdl** will be displayed after the last segment is entered. Press **ENTER** to begin firing. Remember - if you don't want to fire that program just start it and then stop it. You will return to the **IdLE** display alternating with temperature and you can then change programs.

PREHEATING CERAMICS: We recommend you preheat any previously unfired ceramic work at a temperature of 65°C / 150°F for several hours. We have 3 hours programmed into our standard slow bisque program. This will help remove water from the work and could prevent an explosion in the kiln. There is no need to use this will glass or metal work.

REVIEWING THE PROGRAM WHILE FIRING

- 1) Once you have started a program firing you can review it by hitting the **DOWN** (Review) Button.
- 2) The program will scroll. You will see, in the following order, various aspects of the program.
 - a) The program name (**USr 1, USr 2, USr 3, USr 4**)
 - b) Number of Segments (**SEG** followed by some number, i.e. **0004**)
 - c) **rA 1** alternating with the ramp rate.
 - d) **°C 1** alternating with the temperature (i.e. **0900**).
 - e) **HLd1** alternating hold time (i.e. **00.30**)
 - f) The above three steps are repeated for each segment.

CONTROLLED COOLING

You can control the cooling of the kiln by having a segment in the program that ramps down. You ramp down by having the temperature of a segment be lower than the temperature of the previous segment. Note that the first segment has to start with an up ramp.

THE END OF THE PROGRAM

- 1) The control will shut off power to the elements at the end of the program.
- 2) At the end of the program the control will flash **CptL** and a number like **7.34**. The 7 stands for hours and the 34 stands for minutes. This is how long it took for the kiln to reach final set point.

OPTIONS WHILE FIRING

SKIP A STEP

During a firing you may advance from the current segment to the next ramp rate by using **Skip Step** or if you are in a hold period you may add time and temperature to the hold period.

- 1) While firing (running a program) press the **UP** (View Segment) key. The current ramp or hold is displayed followed by the current or traveling set-point, then **SStP** is displayed.
- 2) If you do not press a key within several seconds the display will return to showing the current temperature in the kiln.

THE L&L FUEGO OR ROBIN KILN INSTRUCTIONS (EUROPEAN VERSION)

- 3) When **SStP** is displayed press **ENTER** to skip to the next ramp rate.

ADD TIME TO HOLD PERIOD

This option allows you to add time in 5-minute increments to a hold (soak) period.

- 1) When in a hold period (during a hold or soak, the temperature in the kiln will be alternating in the display with the remaining hold time), press the **UP** (View Segment) key.
- 2) When **SStP** is displayed press the **UP** key again and **tME** will be displayed.
- 3) Press **ENTER** and 5 minutes will be added to the hold time.
- 4) You will see the new hold time displayed.
- 5) You may use this procedure as many times as necessary

PREHEATING CERAMICS:

We recommend you preheat any previously unfired ceramic work at a temperature of 65°C / 150°F for several hours. We have 3 hours programmed into our standard slow bisque program. This will help remove water from the work and could prevent an explosion in the kiln. There is no need to use this with glass or metal work.

IMPORTANT NOTE ABOUT HOLD TIMES DURING THE LAST SEGMENT:

Be careful with hold times in the final segment of a program designed for ceramics - this will add to the heat work and will typically mean you need to fire to a lower temperature to get the same cone result.

ADD TEMPERATURE TO A HOLD PERIOD

This option allows you to add temperature in 5-degree increments to a hold (soak) period.

- 1) When in a hold period (during a hold or soak, the temperature in the kiln will be alternating in the display with the remaining hold time), press the **UP** key.
- 2) When **SStP** is displayed press the **UP** key twice more and **tMP** will be displayed.
- 3) Press **ENTER** and 5 minutes will be added to the hold time.
- 4) If you hit the **UP** key again you will see the new hold temperature displayed briefly.
- 5) You may use this procedure as many times as necessary to get the hold temperature that you want.

CHANGE PROGRAM WHILE FIRING

You can reprogram the control by stopping it and changing the program and then restarting it. The control will compare the current temperature with where the kiln should be in its new program.

To **StOP** the kiln hit **ENTER**. Then hit **ENTER** again and you will see your program name (i.e. **USr2**). Then hit **ENTER** again to reprogram your program. When you see **rEdl** press **ENTER** again to restart the program where you left off. **NOTE IF YOU HAVE A DOWN RAMP IN YOUR PROGRAM:** If there is a down ramp it will look for the first up ramp that has the temperature it is looking for. You may need to use **SKIP STEP** to get back to where you want to be if you have a down ramp in the program.

THE L&L FUEGO OR ROBIN KILN INSTRUCTIONS (EUROPEAN VERSION)

FIRST FIRING TO CONE 6

The first firing of the kiln should be a test fire. Fire it empty except for shelves and posts.

NOTE: You may experience some smoking from the kiln on its first firing. This, if it occurs, is due to residual oil left on the element wire when the elements were made. The test firing should be done with nothing in the kiln except the furniture kit and a cone 6 self-supporting cone or cone pack in each zone of the kiln; top, middle, and bottom. Be sure to monitor the kiln from time to time. Especially watch it in the first few hundred degrees to be sure that the kiln was set up properly and then at the end of the firing to be sure the location you have chosen is safe and that everything is working properly. Run the **USr1** program for 8 hours. Then turn off that program and run the **USr3** program. This can be done at separate times or one after the next. The total time should be about 13 hours.

PRE - SET PROGRAMS

USR1 - SLOW BISQUE TO 1015°C WITH 30 MINUTE HOLD

DISPLAY	VALU E	TIME	COMMENT
dLAY	00.00		Add a delay time in here if you want it
SEG	0006		Six segments
rA 1	50 2	hours	Ramp up at 50°C per hour
°C1	100		100°C set point
Hld1	00.30	30 minutes	to ensure pieces are dry
rA 2	75	1.75 hours	Ramp up at 75°C per hour
°C2	230		230°C set point
Hld2	00.00		No hold - cristobalite inversion phase 223 °C
rA 3	180 1.75	hours	Ramp up at 180°C per hour
°C3	545		545°C set point
Hld3	00.00		No hold – moves immediately to next segment
rA 4	100 1	hour	Ramp up at 100°C per hour
°C4	645		645°C set point
Hld4	00.00		No hold - quartz inversion phase 575 °C
rA 5	180	1.50 hours	Ramp up at 180°C per hour
°C5	915		second to final temperature
Hld5	00.00		No hold – moves immediately to next segment
rA 6	100 1	hours	Ramp up at 100°C per hour
°C6	1015		1015°C - final temperature
Hld6	00.30	30 minutes	soak

Total Estimated Time: 10 hours Note: These are best possible times based on the program. Times will vary with load size, voltage, element age etc.

THE L&L FUEGO OR ROBIN KILN INSTRUCTIONS (EUROPEAN VERSION)

USR2 FAST GLAZE TO 1020 °C

DISPLAY	VALU E	TIME	COMMENT
dLAY	00.00		Add a delay time in here if you want it
SEG	0002		Two segments
rA 1	300	3 hours	Ramp up at 300°C per hour
°C1	900		900°C set point -second to Final Temp
Hld1	00.00		No hold – moves immediately to next segment
rA 2	100	1.2 hours	Ramp up at 100°C per hour
°C2	1020		1020°C set point - Final Temperature
Hld2	00.00		No hold – End of program, start natural cooldown

Total Estimated Time: 4.2 hours (4 hours 12 min) Note: These are best possible times based on the program. Times will vary considerably with load weight, voltage, element age, etc.

USR3 - SLOW GLAZE TO 1180 °C

DISPLAY	VALU E	TIME	COMMENT
dLAY	00.00		Add a delay time in here if you want it
SEG	0003		Three segments
rA 1	100 2.5	hours	Ramp up at 100°C per hour
°C1	250		250°C set point
Hld1	00.00		No hold – moves immediately to next segment
rA 2	230 3	hours	Ramp up at 230°C per hour
°C2	940		940°C set point - Second to Final Temp
Hld2	00.00		No hold – moves immediately to next segment
rA 3	100	2.4 hours	Ramp up at 100°C per hour
°C3	1180		1180°C set point - Final Temperature
Hld3	00.00		No hold – End of program, start natural cooldown

Total Estimated Time: 7.9 hours (7 hours 54 min) Note: These are best possible times based on the program. Times will vary considerably with load weight, voltage, element age, etc. NOTE: This program will not work on The Robin kiln because that kiln can only go up to 1100°C. You can change the final temperature of this program if you want to fire a slow glaze to a lower temperature.

THE L&L FUEGO OR ROBIN KILN INSTRUCTIONS (EUROPEAN VERSION)

OTHER SUGGESTED PROGRAMS

PROGRAM FOR SLUMPING GLASS

People have many different ways and programs for firing glass. Here is one recommendation for slumping that you can try. CAUTION: Be very careful not to over fire glass it can cause a real mess when it melts (like a big hole in your kiln floor) which we cannot be responsible for. Use your peepholes to observe the glass when it starts to slump and be sure to use proper safety glasses (See Cautions).

DISPLAY	VALUE	TIME	COMMENT
dLAY	00.00		Add a delay time in here if you want it
SEG	0003		Three segments
rA 1	204		Ramp up at 204°C per hour
°C1	760		760°C set point
Hld1	00.15	15 minutes	Hold for 15 minutes
rA 2	9999		Ramp down as fast as possible
°C2	510		510°C set point
Hld2	01.00	1 hour	Hold for 1 hour
rA 3	38		Slow Ramp down to anneal glass
°C3	38		38°C set point - to room temperature
Hld3	00.00		No hold – End of program

A FAST BISQUE PROGRAM TO CONE 05

This is a sample of how you would write a program to do a Fast Bisque to Cone 05. You may want to try this on very thin walled pieces but in general the Slow Bisque is a safer way to fire.

DISPLAY	VALUE	TIME	COMMENT
dLAY	00.00		Add a delay time in here if you want it
SEG	0005		Five segments
rA 1	50 1	hours	Ramp up at 50°C per hour
Hld1	0.50	30 minutes	This is the Preheat
rA 2	150	1 hours	Ramp up at 150°C per hour
°C2	200		200°C set point
Hld2	00.00		No hold – moves immediately to next segment
rA 3	100	30 minutes	crystalite inversion phase 223 °C
°C3	250		250°C set point
Hld3	00.00		No hold – moves immediately to next segment
rA 4	310	2 hours	Ramp up at 310°C per hour
°C4	870		870°C set point - Second to Final Temperature
Hld4	00.00		No hold – moves immediately to next segment
rA 5	75	2 hours	Ramp up at 75°C per hour
°C5	1020		1020°C set point - Final Temperature
Hld5	00.00		No hold – End of program, start natural cooldown

On loads that are very important always use cones you can see through the peepholes in case of a failure of some kind.

THE L&L FUEGO OR ROBIN KILN INSTRUCTIONS (EUROPEAN VERSION)

A PROGRAM TO HEAT TO 980 °C AND HOLD FOR 8 HOURS

DISPLAY VALUE	TIME	COMMENT
dLAY	00.00	Add a delay time in here if you want it
SEG	001	One segment
rA 1	9999	As fast as possible
°C1	982	
Hld1	08.00	8 hours 8 Hour hold

OTHER CONTROL OPTIONS

DEFAULT SETTINGS

The Model 3K controller with RMPATE software has several selectable features. These features include:

- 1) Complete beeping sequence. This is the alarm sounding at the end of a firing. The default setting is "On".
- 2) Temperature scale, °F or °C. The default setting is °C.
- 3) Maximum temperature, 927°C, 1093°C, or 1288°C. The default setting is 1288°C.

NOTE: You do not normally have to change these settings. We include them in here only as reference.

COMPLETE BEEPING

There are three choices for the beeping, which occurs when the firing is complete.

- 1) **FULL** - this option causes a continuous beep when the firing is complete. Beeping stops with a key press.
- 2) **On** - this option causes a 15 second beep at complete.
- 3) **OFF** - with this option there is no audible beep at the end of firing.

TEMPERATURE SCALE

- 1) °F - this sets the controller to the Fahrenheit scale
- 2) °C - this sets the controller to the Celsius (centigrade) scale

MAXIMUM TEMPERATURE

With the Fahrenheit scale the maximum programmable temperatures are: With the Celsius scale the maximum programmable temperatures are:

- 1) 2350 °F 1288 °C
- 2) 2000 °F 1093 °C
- 3) 1700 °F 927 °C

THE L&L FUEGO OR ROBIN KILN INSTRUCTIONS (EUROPEAN VERSION)

PROGRAMMING THE OPTIONS

In order to program the above options the controller must first be turned OFF. Press and hold any key while you turn the power back ON. Continue to hold the key until **EdIt** is displayed, then release the button. NOTE: There is NO beep when keys are pressed while programming the following options.

- 1) **FULL**, **On**, or **OFF** will be displayed depending on the currently selected option for Complete Beeping. Press the **UP** or **DOWN** keys to select the option you want and press **ENTER**.
- 2) **°F** or **°C** will be displayed depending on the currently selected option. Press the **UP** or **DOWN** keys to select the option you want and press **ENTER**.
- 3) **1288** will be displayed. Press the **UP** or **DOWN** keys to select the maximum programmable temperature you want and press **ENTER**. The options are now programmed. The controller will continue where it was prior to editing. The controller will fire if it was firing or be in the programming mode where it left off. NOTE: A beep will now be heard with each key press.

ENTERING AN OPTIONAL ALARM TEMP

You can make the control sound an audible sound at a specific temperature. This can be useful to alert you to do something like pay attention to the end of the firing. It is not very loud.

- 1) You can **ENTER** an Alarm Temperature at any time the control is not firing the kiln. It will apply to the next programme you run when you hit **START/STOP**.
- 2) Press the **Alarm** button in the Easy-Options Section at the bottom of the control. See **ALAr** and **9999** cycling over and over. A high value like that means the control will not sound an alarm.
- 3) **ENTER** a four-digit number like **1000**. (This represents 1000°C).
- 4) Hit **ENTER**
- 5) The display will say **CPL** for a few seconds and then start cycling **IdLE**, **TC2** and current temperature.

ERROR CODES

Err1	Error 1 indicates the temperature in the kiln is rising during an up ramp slower than 15°F/hr. If this rate continues for 8 minutes the firing will be stopped. Err1 may be an indication that the elements are worn or that a relay has stopped working.
ErrF	Error F indicates the temperature in the kiln is decreasing during a down ramp less than 15°F/hr. If this rate continues for 8 minutes the firing will be stopped. ErrF may be an indication that a relay has stuck in the on position.
Errd	Error d indicates that the kiln temperature is 100°F above the traveling set point, which is the current desired temperature in the kiln. The traveling set point will increase or decrease according to the programmed rate.
ErrP	Error P is displayed whenever there is a power interruption that is long enough to StOP the firing. If the power interruption is brief the kiln will continue to fire when power is restored; in this case there will no indication of a power failure. To clear the error, press any key.
tC FAIL	tC alternating with FAIL indicates the thermocouple has failed. Replace the defective thermocouple. To clear the error, press any key.
tC-	- The red and yellow thermocouple wires are reversed.

THE L&L FUEGO OR ROBIN KILN INSTRUCTIONS (EUROPEAN VERSION)

DISPLAY MESSAGES

CPLt	Firing Cycle Complete (firing time is alternately displayed).
dELA	Delay. Displays when entering the delay time (hour: minutes) until the start of the firing.
DLy	Delay. Alternates with the remaining delay time until the start of the kiln.
°F #	Segment temperature in °F - Set temperature for a user program.
°C #	Segment temperature in °C - Set temperature for a user program. A decimal point will display in lower right corner.
EdIt	Edit the default options (beeping at complete, temperature scale, maximum programmable temperature)
Err1	Error 1, kiln was heating less than 15°/hr and it has been stopped.
Errd	Error d, kiln temperature is 50° hotter than the set point temperature. Kiln has been stopped.
ErrF	Error F, similar to Err1 but during a down ramp the temperature is decreasing less than 15°/hr. Kiln has been stopped.
ErrP	There has been a power interruption that has stopped the firing. Press any key to clear.
FULL	Beeps continuously at end of firing until a key is pressed.
HLd#	Soak time in hours: minutes at a hold temperature.
OFF	No beeping when firing is complete.
On	
rA #	Ramp Number (rate per hour of temperature increase or decrease).
rEdl	Ready to fire current program. Press START to begin firing.
SEG	Short for Segments. You can ENTER up to 8 segments in a program.
SStP	Skip Step (used to advance to the next ramp)
StOP	The kiln is at IdLE and ready to be programmed. StOP alternates with the current kiln temperature.
USr #	User program number displayed
tMP	Temperature (used in the Skip Step Option. The display actually looks like two “U”s upside down)
tME	Time (used in the Skip Step Option. The display actually looks like two “U”s upside down)

THE KILN DESIGN

SECTIONAL CONSTRUCTION

The Fuego and The Robin kilns are made up of two separate sections that sit on top of a separate kiln bottom. They are attached together by the control panel and hinge.

CONTROL SYSTEM

The automatic programme control uses a thermocouples to sense temperature. The control then automatically adjusts power output (turns the contactor on and off) to heat up the kiln. The programme control varies the target set point for the temperature according to various ramps and soak periods that are programmed in the control. Basic operating instructions are part of this manual.

THERMOCOUPLE

The standard thermocouple is a heavy-duty 8-gauge Type K thermocouple protected with an industrial grade mullite thermocouple protection tube.

REMOVABLE CONTROL BOX

The control panel can be easily removed and sent to your distributor for repairs if ever necessary.

HEATING ELEMENTS IN CERAMIC HOLDERS

The heating elements are designed to have a low watt density and good stretch ratio. These are supported in hard ceramic element holders (a unique L&L feature). This will promote long element and firebrick life.

STURDY ALUMINISED STEEL STAND

Aluminized steel resists corrosion at the high temperatures. The stand has a full plate of aluminized steel under the bottom brick. This allows the bottom brick to move freely while expanding and contracting - which helps prevent broken bottoms. The legs, which have two bends for stiffness, are bolted onto the stand plates. There are plastic feet that slip over the metal legs.

REVERSIBLE BOTTOM

The brick bottom can be easily reversed in case of a firing mishap.

STAINLESS STEEL CASE

This resists most corrosion and strengthens construction. Stainless steel screws are used in case construction.

THREE CASE CLAMPS PER SECTION

The case of each kiln section is held together by three adjustable stainless steel hose clamps. The clamps are easily accessible for occasional tightening.

STAINLESS CLIPS HOLD BRICK LID IN PLACE

Stainless steel "U" clips hold the firebrick in the lid band.

76 mm (3") OF INSULATION

The insulation is a special hand picked lightweight highly insulating firebrick, which is 76mm (3") thick for all European models. In addition a thin layer of non-RCF fibre paper is used as back-up insulation between the stainless case and the brick.

THE L&L FUEGO OR ROBIN KILN INSTRUCTIONS (EUROPEAN VERSION)

LARGE DIAMETER PEEP & VENT HOLES

There is one 25 mm (1") diameter peephole per section for ventilation and cone sighting. In addition there is one vent hole in the top of the European models for manual venting.

VENT-SURE VENT OPTION

The optional Vent-Sure automatic kiln ventilation system by L&L vents harmful fumes away from a kiln to the outside. Carbonaceous materials in clay, china paints and glazes containing oils, glue from decals, and certain glazes and other miscellaneous products generate fumes.

CE CERTIFIED

All Fuego and The Robin European model kilns are CE certified.

ELEMENT SHUT-OFF SAFETY SWITCH

A locking door safety switch shuts off all power to the elements when the door is open. This positive system breaks all power and does not rely on a relay.

LIMITED WARRANTY

(3) THREE YEAR LIMITED WARRANTY

L&L Kilns and vents are warranted to be free of defects in workmanship for a period of three (3) years, starting on the date of original purchase from an authorized L&L distributor, subject to the following terms, including but not limited to, the exclusions and limitations set forth herein. A sales receipt is required for proof of purchase. In addition, your distributor may require you to deliver defective parts for examination. **DO NOT DISCARD PARTS BEFORE CONTACTING DISTRIBUTOR FOR INSTRUCTIONS. FAILURE TO ADHERE TO L&L's INSTRUCTIONS, INCLUDING THOSE CONTAINED IN THE INSTRUCTION MANUAL AND AS STATED HEREIN, WILL VOID THIS WARRANTY.** L&L will replace or repair any defective part that is covered by this warranty and sent freight-prepaid to your local distributor. On-site labor is not covered by this warranty.

EXCLUSIONS AND LIMITATIONS

The following are examples of items that are not covered by and/or circumstances that will void L&L's warranties:

1. Over-firing damage regardless of cause for the over firing. **IMPORTANT:** We specifically warn you not to fire the kiln unattended. No kiln controls are designed to be fail proof shut off devices. L&L is not responsible for damage caused by failure of one of these controls. Kiln should not be left unattended especially during its last phase of firing when it is supposed to stop firing.
2. Reduction firing or salt glaze use of kiln.
3. Damage due to: neglect, mechanical abuse, improper storage, inadequate maintenance, improper use or freight damage.
4. Damage to the elements or element holders due to failure to properly keep the kiln clean (i.e. getting glaze all over the element holders).
5. Damage to the elements or element holders due to failure to properly keep the kiln clean (i.e. allowing glaze to make contact with the element holders).

THE L&L FUEGO OR ROBIN KILN INSTRUCTIONS (EUROPEAN VERSION)

6. Severe corrosion due to improper venting of kiln fumes or exposure to the ambient conditions, including but not limited to rain, snow, dust, and salt air.
7. Damage due to improper electrical installations or use of improper voltage.
8. Firebrick cracking or chipping for any reason. Firebrick is naturally fragile and will chip and crack over time.
9. Failure to report defect within ten (10) days after it becomes manifest or known.
10. Any alteration of parts or design that vary from factory designs.
11. Use of elements and/or other parts other than those supplied by L&L or its authorized distributors.
12. Thermocouple Protection Tubes are not warranted against breakage.
13. L&L's warranty is strictly limited to repair or replacement of defective items. Kilns cannot be returned.
14. Dealers and Distributors are not authorized by L&L to modify and/or assume any other obligations or liabilities other than those expressed in this limited warranty and any such additional obligations are null and void.
15. EXCEPT AS SPECIFICALLY WARRANTED HEREIN, KILNS ARE SOLD AS IS. L&L MAKES NO OTHER WARRANTY, EXPRESS OR IMPLIED, COVERING THE GOODS SOLD AND SPECIFICALLY DISCLAIMS ALL IMPLIED WARRANTIES OF MERCHANTABILITY OR FITNESS FOR A PARTICULAR PURPOSE. Purchaser acknowledges that certain conditions or circumstances may be created or incurred by Purchaser or user over which L&L has no control, including, but not limited to, climatic conditions, improper use, and inadequate maintenance. Purchaser, as a condition of purchase or use, assumes responsibility for and releases L&L from all liability arising out of the use of the kilns attributable to such causes.
16. L&L SHALL NOT BE LIABLE FOR ANY INCIDENTAL OR CONSEQUENTIAL DAMAGES, INCLUDING BUT NOT LIMITED TO, LOST PROFITS, LOSS OF USE, OR OTHER ECONOMIC LOSSES. Purchaser agrees that L&L's total liability for any damages or remedies arising hereunder shall be limited to direct damages in an amount not exceeding the purchase price paid, and the provisions set forth herein constitute the exclusive remedy against, and the entire liability of, L&L in connection therewith. Any action for breach of contract or negligence must be commenced by Purchaser within one (1) year after the cause of action has accrued.

THE L&L FUEGO OR ROBIN KILN INSTRUCTIONS (EUROPEAN VERSION)

ONE YEAR ELEMENT & THERMOCOUPLE WARRANTY

Elements and thermocouples are warranted for one year with the following exceptions:

1. Glaze damage to element caused by accidentally scraping edges of unfired glazed ware against element groove and causing unfired glaze to contaminate element, which causes obvious damage to elements with resultant element failure.
2. Firing of kiln to higher than 1290°C (2350°F).
3. Damage to elements caused by explosion of ceramic object. This may cause small pieces of clay to contaminate the element and cause failure.

SERVICE

TROUBLESHOOTING

See the separate TROUBLESHOOTING SECTION in the Reference Manual

ELECTRICAL SPECIFICATIONS & WIRING DIAGRAMS

See the Reference Manual.

REPLACEMENT PARTS

Parts can be obtained from your local distributor. See PARTS LIST in Reference Manual.

REPAIRING OR REPLACING THE CONTROL PANEL

The control panel is removable from the kiln. This unique L&L Kiln design feature allows easy repair of your control panel. Disconnect power, unplug the kiln, remove panel (see the reference manual for details), pack it carefully in a box with protective cushioning, and send it to your local distributor for inspection and/or repair.

CRACKS IN THE TOP & BOTTOM

It is quite normal to get hairline cracks in both the top and the bottom firebricks. They are caused by the expansion and contraction of the firebrick as it heats and cools. As long as the bottom is fully supported by the stand the cracks in the bottom will not adversely affect the operation of the kiln. It generally does not make sense to cement these hairline cracks.

REGULAR KILN MAINTENANCE

AFTER EACH FIRING

1. Unplug the kiln or turn off at the fused disconnect box.
2. Check element holders and walls for glaze, clay chips or anything that could melt at a high temperature. If melted clay or glaze comes in contact with an element, a rapid failure could result. To clean holders, a good shop vacuum will handle dust and loose crumbs. A very gentle chisel or grinder may help with glaze contamination on element holders, but remember that the elements themselves are quite brittle when they are cool. Replace the contaminated holder if you cannot clean it. Remove any glaze that has splattered on the firebrick or shelves. (USE SAFETY GLASSES WHEN DOING THIS BECAUSE GLAZE CAN BE LIKE BROKEN GLASS). Vacuum afterward. Make sure vacuum is grounded and periodically touch some grounded metal surface away from the kiln to discharge the energy while vacuuming (to protect control from static electricity).
3. Make sure the floor of the kiln and the tops of the shelves are coated with kiln wash. Kiln wash will keep running glaze from ruining a kiln shelf or the floor of the kiln. (Do not coat the undersides or the sides of the shelves because you do not want the kiln wash to fall off into the kiln).
4. Keep a kiln log of firings. Tracking the performance of your kiln over time may turn out to be an extremely valuable tool if you ever need to diagnose future problems.

AFTER 10 FIRINGS

1. Check temperatures of the power lead at the receptacle while the kiln is at its hottest. If these are hotter than normal, it could be a sign of a loose or corroded connection, or possibly the wire gauge used in the power hook-up is the wrong size for the amount of current being drawn by the kiln. Immediately diagnose and fix this because it could cause a fire.
2. Check plug for oxidation or any burn marks, discoloration or melted spots. If you see this replace the plug (and possibly the receptacle) before using the kiln again. Make sure the receptacle feels tight when you press the plug into the outlet. A loose receptacle indicates worn springs, which will lead to overheating. NOTE: you can put an oxidation inhibitor on the prongs.
3. Repair any firebrick problems.

AFTER 30 FIRINGS OR ANNUALLY

1. Check element resistance. You will need a digital multimeter (see the Troubleshooting Guide). Keep track of this information.

THE L&L FUEGO OR ROBIN KILN INSTRUCTIONS (EUROPEAN VERSION)

2. Check tightness of case and retighten if necessary. (the case will expand and contract during each firing and may eventually become loose. Brick also shrinks slightly with use - especially if used at the higher temperatures like cone 10).
3. Check internal wires for deterioration or oxidation. Replace any that seem brittle or where the wire insulation has deteriorated or fallen off. Check terminals for oxidation (discoloration). If you are near salt air or if you notice corrosion on the stainless exterior of the kiln for whatever reason (like certain fumes generated by your work) then do this far more frequently.
4. Check power connection terminals in the kiln and control box for tightness. Be sure to do this with the kiln unplugged. If these terminal connections get loose heat can be generated and this can cause a fire.
5. Check thermocouple connections for corrosion, tightness and oxidation as well. A bad thermocouple connection can change the accuracy of the temperature reading, which could cause an overfiring.

When replacing electrical components, replace the electrical connectors. At the very least check for discoloration (an indication of oxidation).

CHECK THERMOCOUPLE CALIBRATION

Thermocouples will drift in reading over time. This could potentially lead to an overfiring before the thermocouple actually fails. Although you cannot easily check thermocouple calibration, the general accuracy of the entire kiln system can be checked by firing with witness cones.



HARD CERAMIC ELEMENT HOLDERS



- A Unique Feature on All L&L Kilns. Protects interior firebrick from cracked and broken routed element channels.
- No pins required to hold elements in place.
- Improves firing efficiency - hot elements are not insulated from the interior of the kiln by insulating firebrick. There is only 4.75mm (3/16") of dense non-insulating ceramic separating the hot element from the kiln interior.
- Kilns are easier to repair - much easier to change elements with less chance of damaging kiln.

IT'S WHAT MAKES L&L KILNS UNIQUE

ASSEMBLING THE L&L FUEGO OR ROBIN KILN (EUROPEAN VERSION)

TOOLS NEED FOR THE JOB

You will need the following tools for the job:

- 1) Phillips head screw driver (medium size head)
- 2) Knife
- 3) Adjustable Wrench
- 4) 3/8" Nut Driver or socket wrench
- 5) Level

UNPACKING

Inspect for visible damage

The carton should arrive without visible damage. If any carton was damaged in transit, you should either refuse shipment or unpack the kiln in the drivers presence in order to file a damage report with the freight company. **Call the distributor immediately if there is a problem. SAVE ALL MATERIALS UNTIL YOU ARE SURE YOU WON'T NEED THEM. AT THE VERY LEAST NOTE DAMAGE ON THE BILL- OF-LADING - WITHOUT THIS YOU HAVE NO PROTECTION!**

A packed kiln.:



What you see when you open the box:

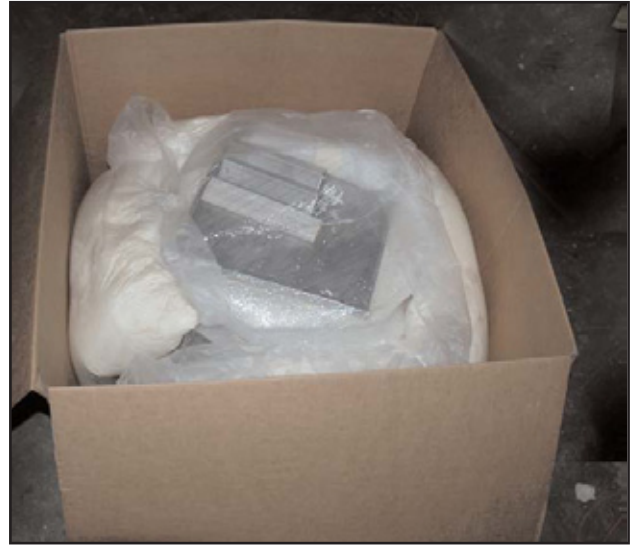

- 1) Cut open the box with a box knife on two corners. (That way you can tape the box up neatly if you need to reuse the box.)
- 2) Save all package material until you are sure the kiln is working properly.
- 3) Carefully remove shrink-wrap with a knife.

ASSEMBLING THE STAND

The stand consists of four legs, the stand plate and (8) 1/4-20 bolts to attach the legs to the stand. You will find all this in the top tray of the box:



ASSEMBLING THE L&L FUEGO OR ROBIN KILN (EUROPEAN VERSION)

The legs get bolted to the stand with 1/4-20 bolts provided. They do not need nuts. Make sure all the stand legs are tight. Use a nut driver or an adjustable wrench to do this:



Fit the rubber-plastic feet over the bottom of the legs. The stand is now fully assembled:



SETTING UP THE BOTTOM

Place the stand on the floor in the desired location. This should be set so that the outside stainless steel surface of the kiln will be at least 30cm (12") to 45cm (18") from any combustible wall. Floor must be nonflammable.



Information concerning clearances, ventilation and electrical requirements is detailed in the INSTALLATION Section of this manual. Read now if you are uncertain about any of these issues. DON'T PROCEED UNTIL YOU ARE COMFORTABLE WITH THE LOCATION THAT YOU SELECT.

Level the stand. Use metal shims under the legs to accomplish the leveling. Make sure that the base will not wobble.



ASSEMBLING THE L&L FUEGO OR ROBIN KILN (EUROPEAN VERSION)

Remove bottom slab from package:



Place the bottom of the kiln on the kiln stand. Center the bottom brick on the stand. It is not critical how the polygonal brick is oriented to the square stand:



ASSEMBLING WITH TWO PEOPLE

If you have two reasonably strong people available you can lift the whole kiln with the two sections and the top attached without disassembling the panel. (If you have only one person - skip this section and use the single person assembly technique).

CAUTION: The two kiln sections and top together of The Robin weigh about 70Kg (150 pounds). Be careful not to strain yourself. The Fuego weighs less and a strong person can probably lift this by him or herself.

Pick up the kiln using the handles on the bottom section and place it on the bottom slab. Adjust it until the bottom section matches the bottom slab:



ASSEMBLING WITH ONE PERSON

You will need to take the control panel off.

Remove one cotter pin from the hinge bar.



Pull out hinge bar:



ASSEMBLING THE L&L FUEGO OR ROBIN KILN (EUROPEAN VERSION)

Set lid off to side (no need to take off door chains unless you want to totally remove door):



Loosen - but do not remove the eight screws holding the control panel to the kiln:



Lift the panel up slightly to slip it off the eight screws on the right:



Swing the panel out leaving it attached to the four loose screws on the left:

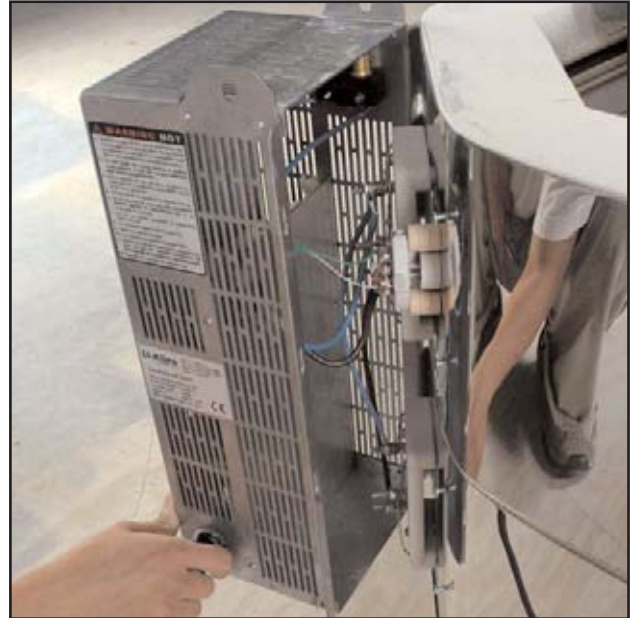

Unscrew the thermocouple wires. Notice that the WHITE wire goes next to the thermocouple wire that is marked RED. (Green wire goes on the unmarked (positive) terminal):

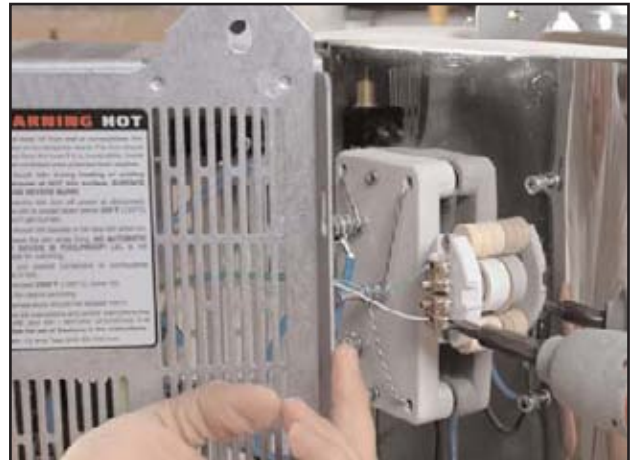

ASSEMBLING THE L&L FUEGO OR ROBIN KILN (EUROPEAN VERSION)

Pull element connection wires off of the Element Power Terminal:

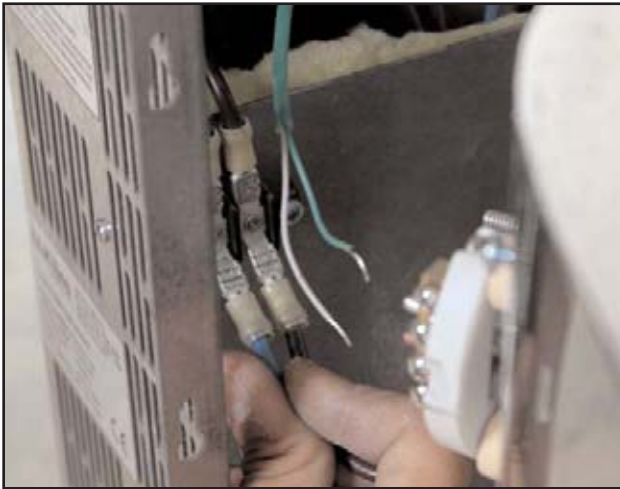

Remove panel and put to one side:

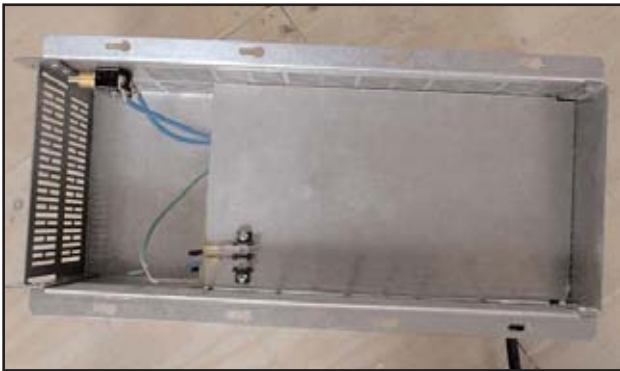

Remove the terminal nuts on the bottom element terminal block so you can remove the element jumper wires that go between the two sections. Use a 3/8" nut driver or socket wrench. Leave the Element Jumper Wires attached to the top section:



Now that the two sections are disconnected from each other you can lift up the top section. Place it down on the ground temporarily:



NOTE: Usually the top section along with the top is light enough that you can move it as an assembly. However, if you need to remove the top you can remove the screws that hold the support chains to the kiln. Again - be careful of lifting too much weight.

Now you can lift up the bottom section and place it on the bottom slab. Line up the edges:



ASSEMBLING THE L&L FUEGO OR ROBIN KILN (EUROPEAN VERSION)

Now place the top section and top on the bottom section and make sure everything is lined up:



Reattach the Element Jumper Wires that go between the sections and attach the Element Connection Wires. A close up showing how all the terminals of the wire and terminal hardware go together (shown before being tightened). Be sure to tighten this well because a loose connection could cause overheating at the terminal:



Hang the panel on the four left mounting screws:

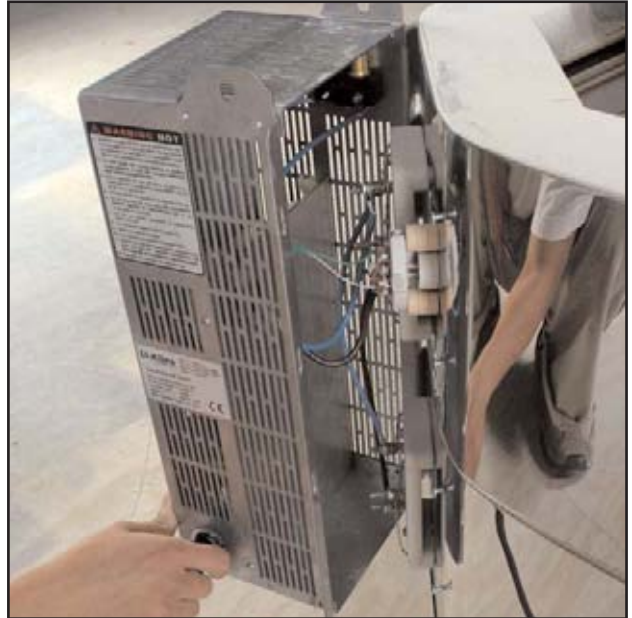

Reconnect the Element Connection Wires to the Element Power Terminal:

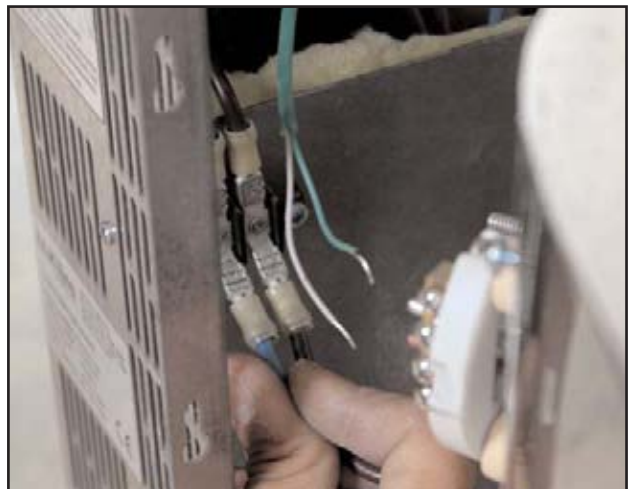

ASSEMBLING THE L&L FUEGO OR ROBIN KILN (EUROPEAN VERSION)

Reconnect the thermocouple wire. **BE SURE TO CONNECT THE WHITE WIRE TO TERMINAL THAT HAS THE RED MARK ON THE WIRE STUB PROTRUDING FROM THE THERMOCOUPLE. THIS IS THE NEGATIVE WIRE (THE GREEN WIRE IS POSITIVE)**

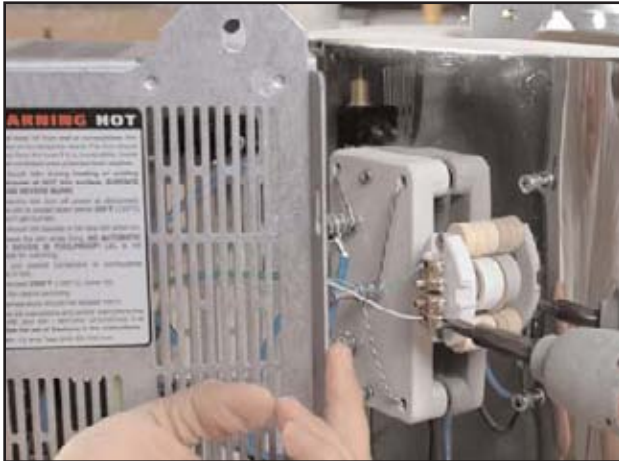

Push the panel in and slip the mounting screws (that you didn't remove) into the keyhole slots on the panel. Tighten the screws:



Make sure the top of the panel is flush with the top of the firebrick:



Reinsert hinge bar:



Replace cotter pin into the hinge bar.



YOU ARE NOW READY TO OPERATE YOUR KILN



The ROBIN

NOTES:

Control Wire:
16 AWG, 105°C
Power Wire:
10 AWG, 150°C

LOOKING INSIDE CONTROL PANEL

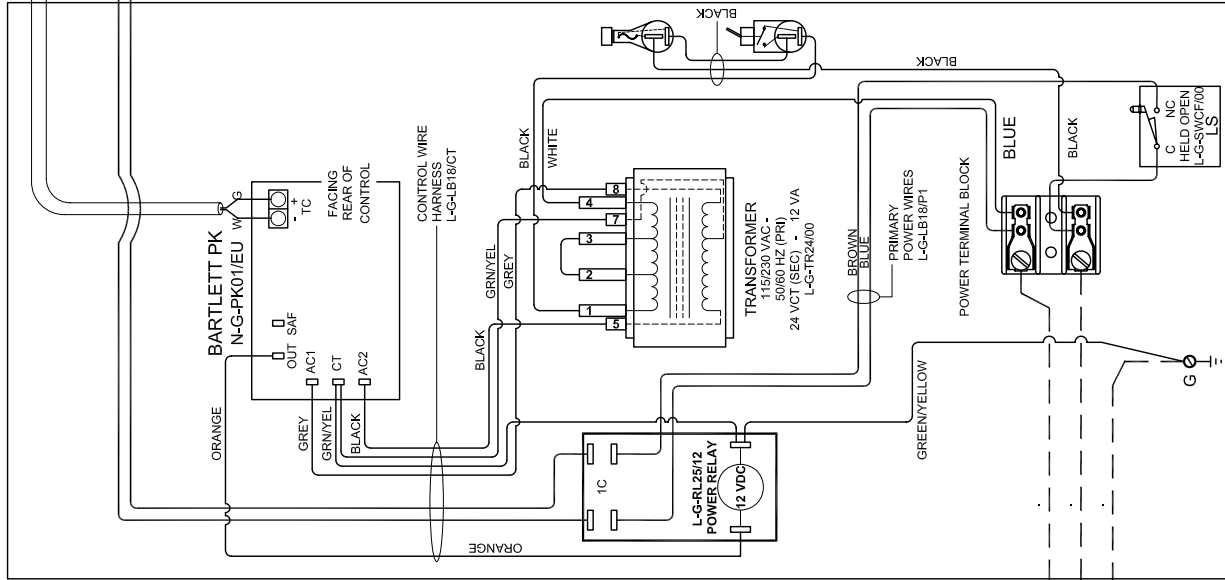

PLUG BY CUSTOMER

LOOKING AT OUTSIDE OF INSULATING PLATE

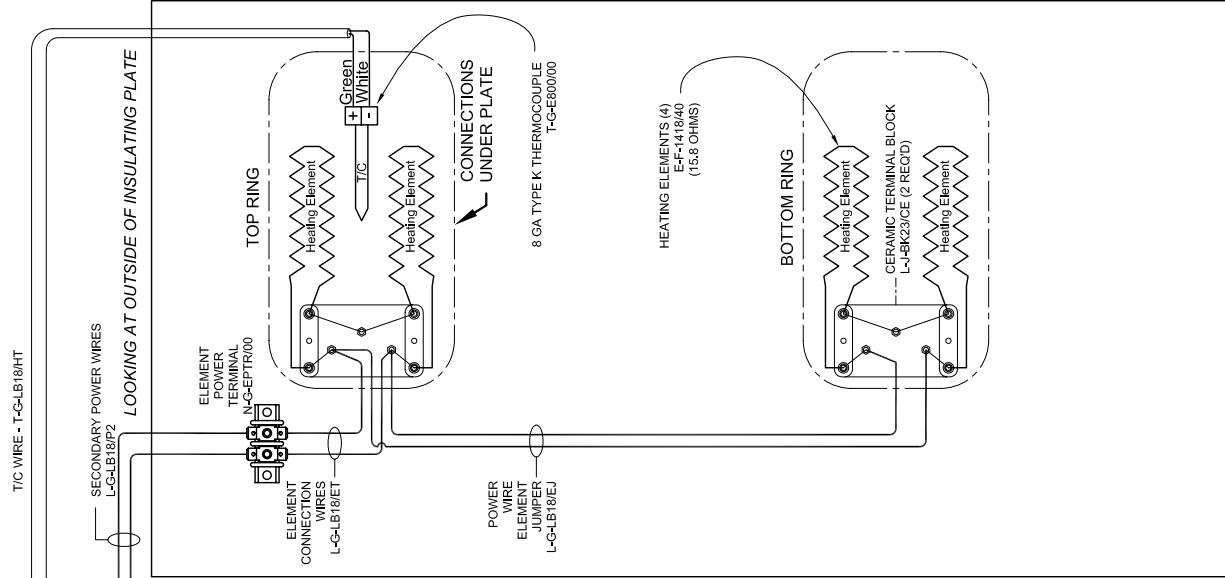

**Models F1418-230-eu
And R1618-230-eu**

VOLTAGE	220-240 / 1 / 50-60
WATTS	~ 3000
AMPS	13

REV #	DATE	REVISION DESCRIPTION
0		
1		
2		
3		
4		
5		
6		
7		
8		
9		
10		
11		
12		
13		
14		
15		
16		
17		
18		
19		
20		
21		
22		
23		
24		
25		
26		
27		
28		
29		
30		
31		
32		
33		
34		
35		
36		
37		
38		
39		
40		
41		
42		
43		
44		
45		
46		
47		
48		
49		
50		
51		
52		
53		
54		
55		
56		
57		
58		
59		
60		
61		
62		
63		
64		
65		
66		
67		
68		
69		
70		
71		
72		
73		
74		
75		
76		
77		
78		
79		
80		
81		
82		
83		
84		
85		
86		
87		
88		
89		
90		
91		
92		
93		
94		
95		
96		
97		
98		
99		
100		



Fuego

PARTS LIST

THE FUEGO OR ROBIN KILN (EUROPEAN VERSION)

TABLE OF CONTENTS

TABLE OF CONTENTS	1
HOW TO ORDER PARTS	1
ELEMENTS	1
PEEPHOLE PLUGS	1
ELEMENT TERMINAL BOARDS	1
THERMOCOUPLES	2
THERMOCOUPLE LEAD WIRE	2
CONTROL FUSE	2
ON/OFF TOGGLE SWITCH	2
ELEMENT CUT-OFF SWITCH	3
CONTROL BOARD	3
CONTROL TRANSFORMER	3
POWER RELAY	3
POWER TERMINAL BLOCK	4
ELEMENT POWER TERMINAL	4
CERAMIC ELEMENT HOLDERS	4
TOP & BOTTOM FIREBRICK SLABS	5
SIDE FIREBRICK - BRICKS & SECTIONS	5
CEMENT & BRICK REPAIR	6
MISC DOOR HARDWARE	6
CONTROL BOX & INSULATION	6
HINGE PARTS	7
STANDS	7

HOW TO ORDER PARTS

How to Place an Order

Order parts from your local distributor.

Prices

Prices in this parts list are in US dollars. However, your local distributor will have prices listed in the proper currency for you.

Have the Nameplate Information

You can get Model Number, Serial Number and Voltage information about your kiln from the Data Nameplate affixed to your kiln. Please have this available when ordering parts.

ELEMENTS

E-F-1418/40.....\$30.00
The Fuego and Robin 230 Volt element. There are four elements in the kiln. They are all the same resistance. These are the same for either The Fuego or The Robin kiln.

PEEPHOLE PLUGS

C-G-PEEP/00.....\$7.00
Peep Hole Plugs 25mm (1") OD x 125mm (5") Long. These have a stepped head to act as a heat lock around the perimeter. These are also used to plug the vent holes on the top of the kiln.

Below is a C-G-PEEP/10 peephole plug:



ELEMENT TERMINAL BOARDS

CERAMIC TERMINAL BLOCKS

L-J-BK23/CE.....\$22.00
All-Ceramic Element Connection Board. Comes with terminal hardware (three terminal posts) and mounting screws to mount onto the kiln.

Below is the front of a L-J-BK18/CE ceramic element connection board:



M-G-TSET/00.....\$3.00
Element Board Terminal Set. Price is for the whole set. Includes: One #10-24 SS bolt 1-1/4" long, One SS lock washer, Three #10-24 SS nuts, Four #10 SS flat washers. There are three sets used per terminal block.

PARTS LIST

THE FUEGO OR ROBIN KILN (EUROPEAN VERSION)

Below is the complete Element Board Terminal Set:

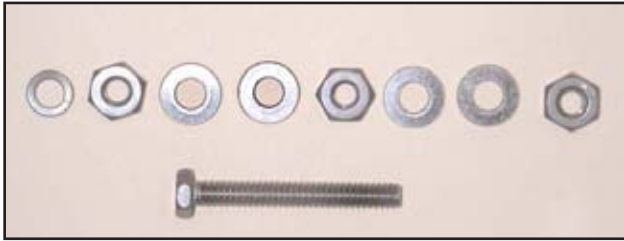

M-A-SMS3/00.....\$0.35
#8 x 1-1/2" long Stainless Steel Sheet Metal Screw. #8 X 1 1/2" Phillips Pan Head. These are used to attach thermocouples to the kiln and to attach Element Terminal Blocks to kiln. (12 used on a 3 section kiln, 8 used on a 2 section kiln)

THERMOCOUPLES

T-G-E800/00\$26.00
8 Gauge Type K Thermocouple with ceramic terminal block. Mounting kit is not included.

Below is a T-G-E800/00 8 Ga Thermocouple.

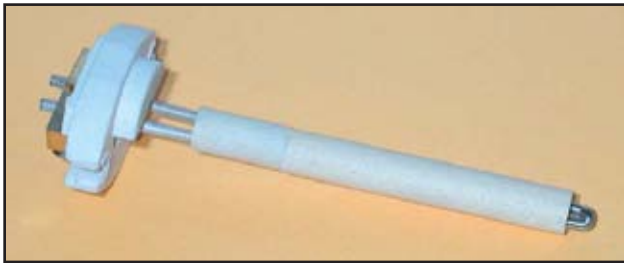

T-G-MKIT/00.....\$6.00
Mounting Kit for Thermocouple. Includes two screws and six 6.4mm (1/4") high ceramic standoffs.

Mounting kit for thermocouples shown with a thermocouple:



T-G-TUBE/00.....\$25.00
Industrial Mullite Protection Tube. This goes over the 8 gauge thermocouple and protects the thermocouple from as rapid corrosion. It is 19mm (3/4") OD by 12.7mm (1/2") ID.

Below is a T-G-TUBE/00 Industrial Mullite Thermocouple Protection Tube:



THERMOCOUPLE LEAD WIRE

T-G-LB18/EU.....\$10.00
Thermocouple Lead Wire. This goes from the control board to the thermocouple. This is color-coded for European standards.

CONTROL FUSE

This fuses the control circuit. It is located by the On/off switch and the fuse is accessible from outside the panel.

L-C-FS05/00.....\$1.00
1/2 Amp Fuse Panel Mount (3AG-1/2, 250V)

L-G-FSPB/00.....\$12.00
Panel Mount Fuse Holder for Control Fuse

Below is a panel mounted fuse holder and use:



ON/OFF TOGGLE SWITCH

L-G-SWTG/00\$15.00
On/Off Toggle Switch.

Below is the L-G-SWTG/00 On/Off Switch:



L-G-SWTG/PL.....\$1.50
Toggle Switch Legend Plate.

PARTS LIST

THE FUEGO OR ROBIN KILN (EUROPEAN VERSION)

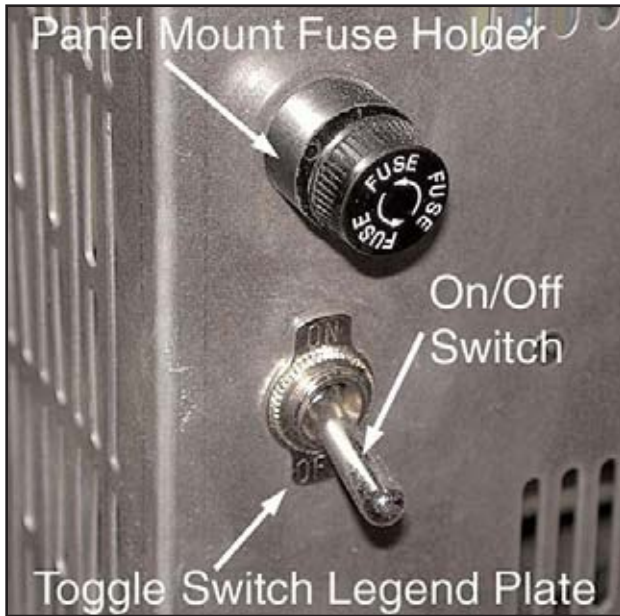

Below is the N-G-PK01/EU Board viewed from the front.



ELEMENT CUT-OFF SWITCH

L-G-SWCF/00\$55.00
Element Cut-Off Switch.

Below is the L-G-SWCF/00 Element Shut-off switch:



CONTROL TRANSFORMER

L-G-TR24/00\$28.00
12 VA Control Transformer

Below is the L-G-TR24/00 12VA Control transformer. The arrow points to the terminal numbers that correspond to the wiring diagram:

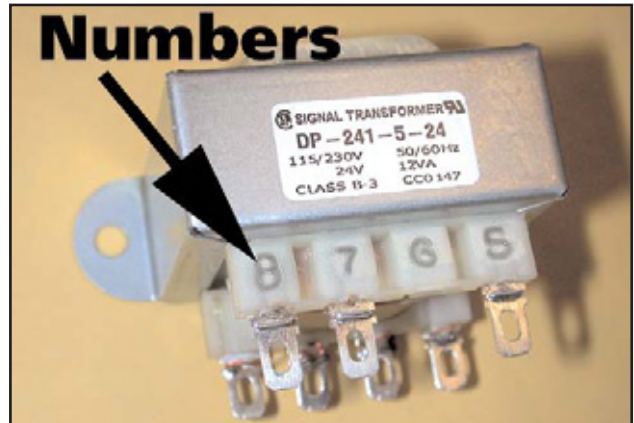

CONTROL BOARD

N-G-PK01/EU\$175.00
PK Bartlett Electronic Control Board. This is made especially for the European models. It includes an offset preprogrammed in for the thermocouple protection tube, special programmes and Degrees reading in Degrees C.

POWER RELAY

L-G-RL25/12\$25.00
25 Amp Enclosed Power Relay, 12 Volt Coil.

Below is a 25 Amp enclosed power relay:

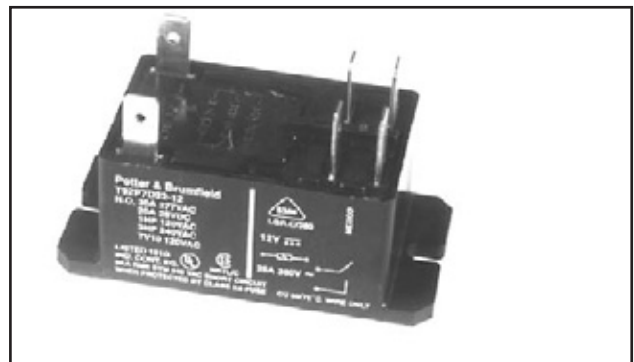

PARTS LIST

THE FUEGO OR ROBIN KILN (EUROPEAN VERSION)

POWER TERMINAL BLOCK

The Power Terminal Block is the main terminal that the Power Cord gets attached to. The wires feed from this block to the Power Relay and Control Transformer.

L-G-PB2P/EF\$20.00
Single Phase Power Connection Block 2 pole.

Below is a L-G-PB2P/EF 2 pole Connection Block:



ELEMENT POWER TERMINAL

N-G-EPTR/00\$8.00
Element Power Terminal. This is the two prong terminal strip that is mounted to the insulation plate. The Secondary Power Wires from the Power Relay connect to this terminal strip as do the Element Connection Wires. This connection point makes disconnecting the panel from the kiln easy.

Below is the Element Power Terminal:



CERAMIC ELEMENT HOLDERS

Hard ceramic element holders are one of the unique features that make L&L Kilns so long lasting and valuable. See the Troubleshooting Section for details on replacement if ever necessary.

ELEMENT HOLDER LENGTHS

Element Holders come in several different lengths. The following is a list of the various sizes as they are used in the different models.

The Fuego: There are two 76mm (3") holders per brick per normal side. On the brick where the element connections come through there is one 38mm (1-1/2") holder and one 76mm (3") holder per brick.

The Robin: There is one 76mm (3") holder and one 89mm (3-1/2") holder per brick per normal side. On the brick where the element connections come through there are two 66mm (2-1/2") holders per brick.

Below is C-G-EH39/TN #542 element holder:

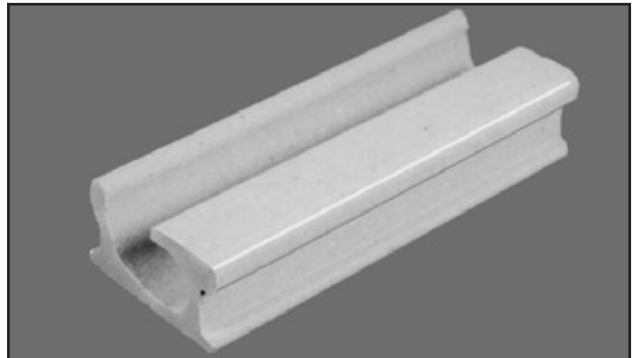

ELEMENT HOLDER PRICES

C-G-EH15/TN	\$4.00
38mm (1-1/2") Long #542 Element Holder	
C-G-EH25/TN	\$4.25
66mm (2-1/2") Long #542 Element Holder	
C-G-EH30/TN	\$4.00
76mm (3") Long #542 Element Holder	
C-G-EH35/TN	\$4.00
89mm (3-1/2") Long #542 Element Holder	

PARTS LIST

THE FUEGO OR ROBIN KILN (EUROPEAN VERSION)

TOP & BOTTOM FIREBRICK SLABS

Tops and bottoms include stainless bands. Hinge parts and handle are not included. If you order a handle and/or a door hinge part you may request to have these installed at no charge.

TOP FIREBRICK

P-J-1403/TP\$105.00
Top for The FUEGO

P-J-1803/TP\$135.00
Top for The ROBIN

STAINLESS STEEL TOP CLIPS

These are the thin stainless steel clips that get attached to the lid band and help hold the brick in place. Two are sandwiched together in each spot.

S-J-CLIP/18.....\$3.50
Stainless Steel Top Clip

Below is shown a stainless steel angle clip used to hold firebrick into top band:

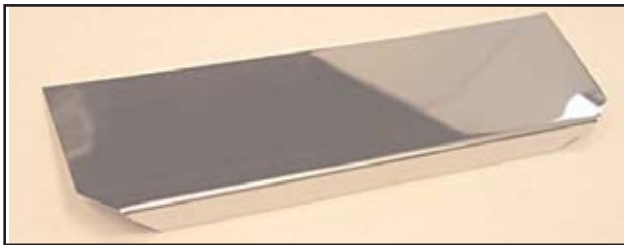

BOTTOM FIREBRICK

Below is shown a bottom being put on a stand:



P-J-1403/BT\$105.00
Bottom for The FUEGO

P-J-1803/BT\$135.00
Bottom for The ROBIN

SIDE FIREBRICK - BRICKS & SECTIONS

SINGLE SIDE BRICKS

Sidebricks are single 228mm x 114mm x 76mm (9" x 4-1/2" x 3") bricks cut with the proper angles, relief cuts in the back and grooved for element holders. If you need the brick where the elements go through the then specify that so that the proper element holders will be put in. The holes for the element connections must be drilled in the field.

Below shows the inside of a kiln:

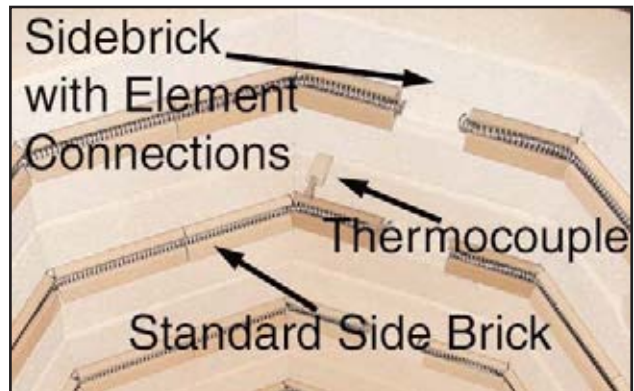

SIDEBRICK FOR FUEGO

F-E-1403/00.....\$16.00
Sidebrick for Fuego. Includes a full line of ceramic element holders for the typical side.

F-E-1403/EL\$16.00
Sidebrick for element connection side for the Fuego. Includes two short element holders with a gap in the middle for the special brick where the elements connections go through.

F-E-1403/NH\$8.00
Sidebrick for Fuego. (No Element Holders).

SIDEBRICK FOR THE ROBIN

F-J-1803/00\$18.00
Sidebrick for the Robin. Includes a full line of ceramic element holders for the typical side.

F-J-1803/EL\$18.00
Sidebrick for element connection side for the Robin. Includes two short element holders with a gap in the middle for the special brick where the elements connections go through.

F-J-1803/NH.....\$9.50
Sidebrick for the Robin. (No Element Holders).

PARTS LIST

THE FUEGO OR ROBIN KILN (EUROPEAN VERSION)

CEMENT & BRICK REPAIR

CEMENT & BRICK FACING

M-G-0050/00\$7.50

Hi-Temp Cement (1/2 pint). This is Brick Cement is the actual cement we use to cement our tops and bottoms together.

M-G-0050/PH\$15.00

Special Phosphate Bonded Cement (1/2 pint). This is a type of cement with extremely good bonding properties - perfect for repairs.

M-G-F050/00\$7.50

Facing (1/2 pint) Facing is the special coating we formulate to harden and coat the firebrick.

F-G-BRCK/30.....\$5.50

228mm x 114mm x 76mm (3" x 4-1/2" x 9") UNCUT BRICK

BRICK REPAIR KIT

M-G-BKIT/00\$27.00

Brick Repair Kit. This is a special kit which includes a 1/8 pint of very special phosphate bonded firebrick cement, 1 quart of firebrick dust, 1 small firebrick piece, 1/2 pint brick facing and detailed instructions. With this kit it is possible to repair many firebrick problems (such a gouges) to almost like new condition.

CERAMIC FIBER

F-G-FIBR/PR\$5.00

(per linear foot x 22cm / 8-1/2" wide) Non-RCF ceramic fiber PAPER 3mm (1/8") thick. This is a non-hazardous version of ceramic fiber. It is used to wrap the outside of the bricks.

F-G-FIBR/00\$16.00

(per linear foot x 60cm 24" wide) Non-RCF ceramic fiber BLANKET. This is a non-hazardous version of ceramic fiber. It is soluble in the human body (i.e. lungs). It will withstand about 1250 Deg C - beyond which it will shrink and/or melt. This is great for stuffing around thermocouple holes and general gasketing. One linear foot is 60cm (24") wide by 30cm (12") long by 2.5cm (1") thick.

MISC DOOR HARDWARE

HANDLES

M-G-HNDD/00.....\$8.00

Lid Handle and Section Handle. Zinc plated.

Below is the M-G-HNDD/00 handle:



DOOR CHAIN

M-G-CNDR/LB (Price per 16" length)\$3.00

Door and Safety Chain (#8) This is the chain that attaches the door to the kiln. Each chain is 44cm (16") long. This attaches to the kiln and lid with #6 1/2" Philips Head stainless screws.

Below is the M-G-CNDR/00 chain :



CONTROL BOX & INSULATION

This is the aluminized metal box that houses the controls and covers the elements. Inside the box is a separate removable plate with a layer of insulation in it. This plate protects the control components from the heat of the kiln. These parts are identical for both models.

S-E-F14X/00.....\$60.00

Control Box.. Includes four mounting screws. Aluminized steel.

S-E-F14P/00.....\$15.00

Insulation Plate. Includes four mounting screws. Aluminized steel. Does not include insulation.

S-E-LBPL/IN\$10.00

Control Insulation. Fits into the Insulation Plate without glue.

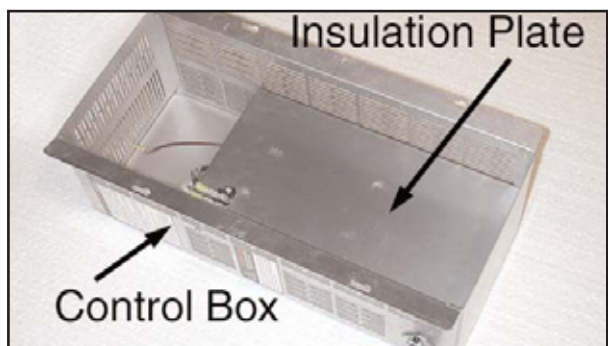

PARTS LIST

THE FUEGO OR ROBIN KILN (EUROPEAN VERSION)

HINGE PARTS

- S-F-HNGE/00**\$25.00
Door Hinge Part. Includes the parts that attach to the kiln.
- S-G-PINX/14**.....\$9.00
Hinge Bar. The hinge pin to a solid 9.5mm (3/8") roundbar with holes drilled in the end for cotter pins.) The pin is 10" long and is chrome plated.
- S-G-COTT/00**\$1.00
Cotter Pins (two in a set). Price is for two.

STANDS

The kiln stands are made of a luminized steel which resist corrosion even at the high temperatures experienced on the stands. The design of the legs is very sturdy with several stiffening bends. The top of all the stands is a sheet of aluminized steel with two bends on the sides for great structural strength. This will provide good support for the entire brick bottom. All stands are 20cm (8") high. The same stand is used for both models.

- A-J-1800/00**.....\$52.00
Heavy Gauge (14 Ga) Aluminized Steel Stand. When you order a stand you will get the stand top, legs plastic feet and appropriate hardware set all included.
- A-J-FOOT/00**.....\$2.00
Plastic Foot for stand legs

Below shows the A-J-FOOT/00 Plastic Foot for the stands:



- A-J-LEGP/00**.....\$5.50
Stand leg with PEM type threaded fastener.
- A-J-HARD/PM**.....\$4.00
Hardware for attaching legs. Includes (8) bolts.

Below is an assembled stand:



- C-G-T120/00**.....\$4.60
30cm (12") Triangular Post



Ask about our larger Easy-Fire Kilns!



Easy-Fire

TROUBLESHOOTING

TROUBLESHOOTING & FIXING THE FUEGO OR ROBIN KILN (EUROPEAN VERSION)

TABLE OF CONTENTS

<p>TABLE OF CONTENTS1</p> <p>LIVE TESTS3</p> <p>DISPLAY DOESN'T SHOW ANYTHING4</p> <p>On/Off Switch4</p> <p>Fuse4</p> <p>Plug & Cord4</p> <p>Circuit Breaker / Power Source4</p> <p>Internal Wiring4</p> <p>Short Circuits5</p> <p>Control Transformer5</p> <p>Control Board6</p> <p>DISPLAY READS FAIL and tC6</p> <p>DISPLAY IS NORMAL BUT KILN WON'T HEAT UP6</p> <p>Programming6</p> <p>Wiring6</p> <p>Control Board Outputs6</p> <p>Bad Power Relay6</p> <p>Bad Elements7</p> <p>KILN FIRES UNEVENLY7</p> <p>Peepholes7</p> <p>Lid Seal7</p> <p>Elements7</p> <p>Loading7</p> <p>Firing with Cones7</p> <p>KILN FIRES TOO HOT OR COLD8</p> <p>Firing with Cones8</p> <p>Hold Times8</p> <p>Thermocouple Drift8</p> <p>KILN STALLS9</p> <p>KILN FIRES SLOWLY9</p> <p>Bad or Wrong Voltage9</p> <p>Element Aging9</p> <p>Power Relays10</p> <p>Bad Wiring10</p> <p>Wiring in the Kiln11</p> <p>Element Connections11</p> <p>Heat Leakage & Vents11</p> <p>Adding More Insulation11</p> <p>KILN HEATS TOO FAST12</p> <p>Voltage12</p> <p>Elements12</p>	<p>ERROR MESSAGES12</p> <p>Errd12</p> <p>Err112</p> <p>ErrP12</p> <p>ErrF13</p> <p>tC-13</p> <p>FAIL13</p> <p>Can you restart the kiln after it stops because of Error Codes?13</p> <p>Worst Case Scenario for Restarting After an Error Code ..13</p> <p>REMOVING PANEL FOR SERVICE13</p> <p>REPLACING CONTROL14</p> <p>REPLACING TRANSFORMER14</p> <p>REPLACING POWER RELAY14</p> <p>REPLACING FUSE HOLDER15</p> <p>REPLACING THERMOCOUPLES15</p> <p>REPLACING ELEMENTS15</p> <p>REPLACING ELEMENT HOLDERS17</p> <p>Method #117</p> <p>Method #218</p> <p>CRACKS IN THE LID & BOTTOM19</p> <p>TIGHTENING STAINLESS BANDS19</p> <p>REPLACING FIREBRICK IN SIDES19</p> <p>DRILLING OUT HOLES FOR PEEPHOLES ..20</p> <p>DRILLING OUT FOR THE ELEMENT CONNECTIONS20</p> <p>REPLACING BOTTOMS20</p> <p>REPLACING LIDS21</p> <p>CHECKING ELEMENT OHMS21</p>
---	---

TROUBLESHOOTING & FIXING THE FUEGO OR ROBIN KILN (EUROPEAN VERSION)

Photo of inside a control panel

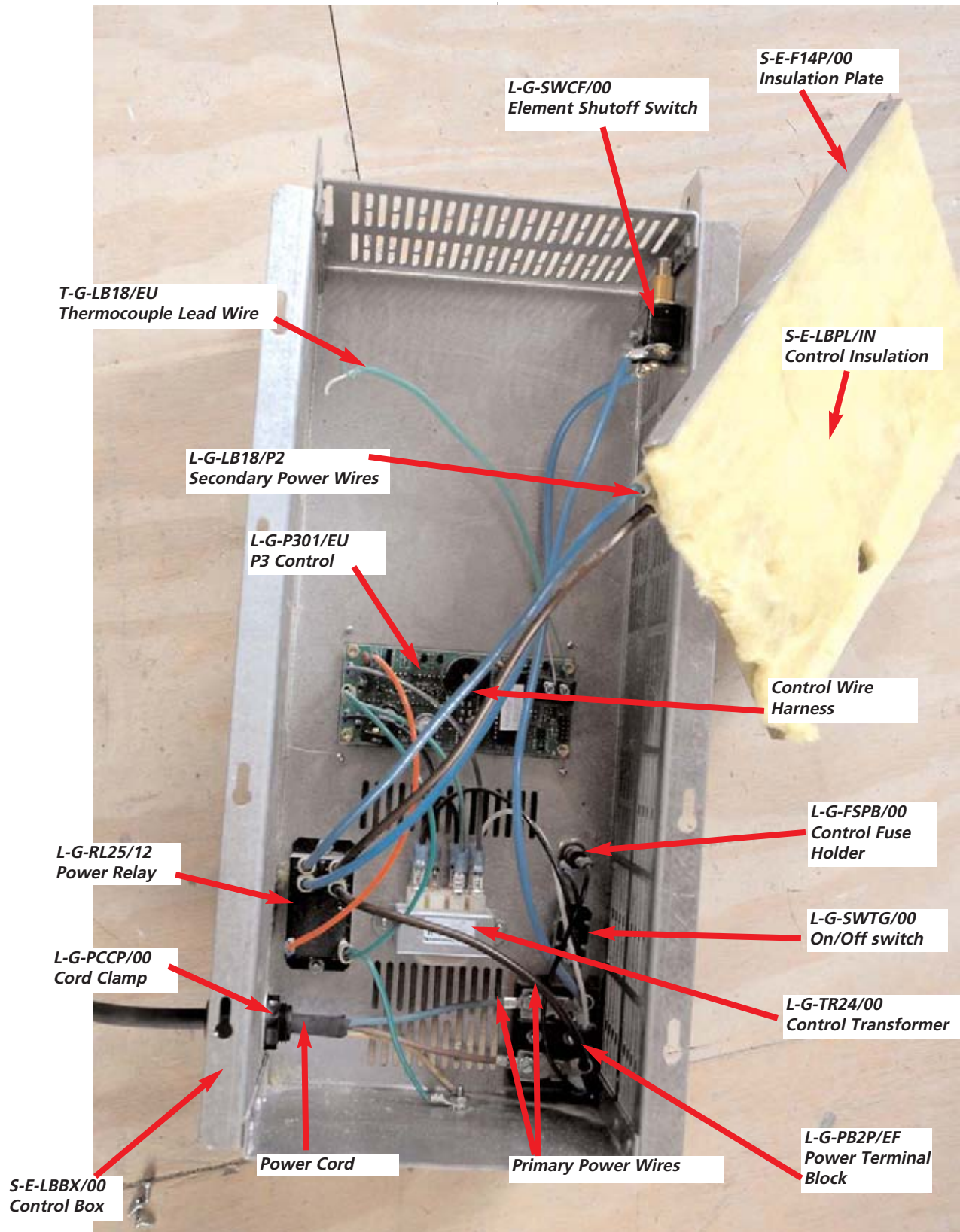

TROUBLESHOOTING & FIXING THE FUEGO OR ROBIN KILN (EUROPEAN VERSION)

CAUTION - ELECTRICITY CAN KILL

Many of the tests described in here are performed under power. They should be done **ONLY** by someone who is familiar with electrical safety such as an electrician or trained maintenance person. We identify any test that is live with a **CAUTION** statement. We describe these tests in detail so that an electrically trained person who doesn't specifically understand kilns can do the troubleshooting - the level of simplicity described is not meant as an invitation to harm the untrained. **AS LONG AS THE KILN IS UNPLUGGED YOU ARE SAFE.**

GET A DIGITAL MULTIMETER!

We recommend the purchase of a digital electrical multi-meter. Without it you are only guessing at the origin and severity of an electrical problem based on how the kiln is acting. Be forewarned however: Testing electrical circuits is very dangerous and potentially deadly if you do it incorrectly. It could result in electrocution! If you don't feel comfortable doing this hire an electrician or get someone to do it who is qualified. That being said - many of the tests described in here just require testing for resistance - which is done with the kiln unplugged. **AS LONG AS THE KILN IS UNPLUGGED YOU ARE SAFE.**

AN EASY-TO-USE TROUBLESHOOTING GUIDE

This troubleshooting guide is written specifically for the Fuego and the Robin kilns. We have tried to thoroughly illustrate it to guide you through step-by-step to solve most of the potential problems you might encounter. It is organized by symptom and potential causes and solutions. There are two major sections. The first section tells you how to diagnose the problem. The second section provides detailed explanations on how to change components and fix various problems.

LIVE TESTS

Some tests are done live. These should be done only by someone experienced in working with electricity. You are dealing with over 200 volts which can easily electrocute you.

Some of the tests involve removing the control panel from the kiln and taping off the power leads and then plugging it in. See the **Assembly Instructions (the section called "Assembling with One Person."** After panel is removed unscrew the insulation panel and tape off the Secondary Power Wires.

Remove the Insulated Panel by removing the four screws on the side of the Control Box:



This shows the control panel off the kiln with the power leads (secondary power wires) taped off with electrical tape. Be sure to surround the entire terminal end with two wraps of electrical tape. Be sure to use electrical tape - other kinds of tape may not insulate from the high voltage.:



TROUBLESHOOTING & FIXING THE FUEGO OR ROBIN KILN (EUROPEAN VERSION)

CONTROL DISPLAY DOESN'T SHOW ANYTHING

On/Off Switch

1) Make sure the On/Off Switch is turned on. Turn it on and off.

Fuse

2) Check control fuse in front of control box. Twist open the fuse holder and physically check the little fuse. You can see if the metal element inside is melted if it is blown. You can also use your digital multi-meter to check continuity across the fuse.

Picture of the on/off switch and fuse holder opened.



Plug & Cord

1) Make sure the power cord is plugged into the receptical. Reseat plug. Make sure it is held firmly and that the springs inside the receptical seem to be working.

2) With power off examine the electrical cord. Look for burned or melted areas and breaks or pinched sections. Look closely at the head of the plug. If there is an internal problem with the wires and the plug parts you won't be able to see it but you may detect a softening or melting of the plastic at the plug head. Look for oxidation or substantial discoloration or even burnt spots on the prongs. Replace plug and cord if this is questionable. Open up the head of the plug and check the connections inside.

3) With panel removed from kiln, power leads taped off like shown, and panel plugged in check voltage at the Power Terminal Block. If you see no voltage there then you know something is wrong with the power source. **CAUTION: This test should only be done**

by an experienced person familiar with electricity and its dangers.

Checking voltage at the Power Terminal Block:



Circuit Breaker / Power Source

1) Check circuit breaker or fused disconnect switch to make sure it is turned on. Sometimes circuit breakers need to be turned on and off to reset them.

2) Check voltage at the receptical. **CAUTION: This test should only be done by an experienced person familiar with electricity and its dangers.**

3) If you have a fused disconnect check the fuses with your voltmeter for continuity. **CAUTION: This test should only be done by an experienced person familiar with electricity and its dangers.**

4) Make sure fuses or circuit breaker is the proper amperage and type. If your fuse keeps blowing try changing it with a slow blow fuse. If a circuit breaker keeps blowing it may need to be replaced.

5) Test for voltage at the main power supply as close to the kiln as possible. **CAUTION: This test should only be done by an experienced person familiar with electricity and its dangers.**

Internal Wiring

1) Unplug kiln and remove panel. Remove the inner insulated panel and look inside at the wires. Make sure that all the wires inside the control panel are connected. See photograph on page 2 and also the Wiring Diagram. Specifically look at the wires that go

TROUBLESHOOTING & FIXING THE FUEGO OR ROBIN KILN (EUROPEAN VERSION)

from the power connection block to the on/off switch, then to the control fuse and then to the control transformer.

Short Circuits

Do all the following with the kiln unplugged.

1) Check for short circuits. Look for any signs of burnt wires. This might indicate a short circuit. A way this might happen, as an example, is that frayed wires at the end of a wire connector might touch each other.

2) Check for worn wires that may have shorted against the case. Examine wire insulation. If the wire insulation has become frayed the wires could short to the metal casing which is electrically grounded.

3) Look for dirt. Some dirt (such as carbon compounds) are electrically conductive. This is generally not the case with ceramic materials but some can be. Vacuum out panel if you see dirt.

NOTE: Usually a short circuit will trip the circuit breaker for the kiln or the fuses in the fused disconnect switch if you have one. You will then not see any display on the control. Turn your circuit breaker on and off, and check fuses on the fused disconnect and control fuse.

Control Transformer

CAUTION: These tests should only be done by an experienced person familiar with electricity and its dangers.

1) If none of these solve the problem then you could have a bad control transformer. To check the transformer operation test with your digital multimeter. It should read 220 to 240 volts across terminals 4 & 1 (where the black & white wires come into it) and 24 volts across terminals 5 & 8 (where the gray and black wires come out). This is a live test so be very careful not to touch any of the wires - remember there is 220 to 240 volts in the panel and this can electrocute you. See photo below. If you are not getting proper voltage (or any voltage from the transformer and you are getting it to the transformer then you need to replace the transformer.

2) If there is 220 to 240 volts coming into the control transformer (terminals 4 & 1, black & white wires)

and there is no voltage coming from the transformer then you have a bad control transformer and it needs to be replaced.

3) The voltage across the top center tap (terminal #7, green-yellow wire) and either of the two top end taps (terminal #8, grey wire or terminal #5, black wire) should be between 12 and 16 volts.

4) The voltage across the two top end taps (terminal #8, grey wire or terminal #5, black wire) should be between 24 and 32 volts.

Checking input of the Control Transformer across terminals 4 & 1 (DANGER-live test):



Checking output of the Control Transformer across terminals 5 & 8 (DANGER-live test):



5) If there is no voltage coming into terminals 4 & 1, white & black, then test for it at the Power Terminal Block where the power cord comes in. If there is power there then look for a bad connection or wire between the power connection block and the trans-

TROUBLESHOOTING & FIXING THE FUEGO OR ROBIN KILN (EUROPEAN VERSION)

former, i.e. a bad toggle switch, wire, or ½ amp fuse holder. If power is not there then go further back on the line and measure the voltage. Keep going until you find voltage, then look for the problem between that point with the voltage and the last point checked that had no voltage.

Control Board

1) If the transformer is OK and you know you have voltage going to the control board but the control still shows no display then the control board needs to be replaced.

DISPLAY READS FAIL and tC

FAIL will be seen flashing along with a **tC** indicating the thermocouple has failed.

1) Check thermocouple end. Examine end carefully. Sometimes there can be a crack that opens up while the kiln is hot but appears to be normal when the kiln is cold. If the end of the thermocouple looks severely corroded and you are getting Error codes then it is best to replace the thermocouple. NOTE: You have to open up the Element Cover Box and remove the thermocouples to check the ends.

A thermocouple end that will still work but is getting close to creating a problem:



2) Check thermocouple circuit. For instance check where the thermocouple lead wires go into the ends of the thermocouples. Are the wires loose? Tighten the screws on the ends of the thermocouples to be sure you have a tight connection. Check for corrosion. Check where the thermocouples connect to the control. Try pulling off each connection and reseating it. This can scrape away corrosion that may have built up. Check for melted wires.

3) If none of this works try testing the control board. Put a small jumper like a paperclip across the thermocouple terminals directly on the control board. If the control now reads room temperature then you have a bad thermocouple wire (or bad thermocouple). If it does not read room temperature then the control is definitely bad and needs to be replaced.

4) If you have a bad thermocouple replace it with a new one.

DISPLAY IS NORMAL BUT KILN WON'T HEAT UP

Programming

1) Make sure you have programmed the kiln properly and it is supposed to be firing. Read the instructions.

Wiring

1) Unplug kiln. Remove panel. Check all power wires for firm connections.

2) Pull off and reseal all the spade connector connections of the power wires to rub off any oxides and to ensure a good connection.

Control Board Outputs

1) It is possible that the the internal switches on the control board could be bad. You can test that by checking to see if you find voltage (12 volts DC) between the output contacts (AC1 & AC2 marked on the control board) ground (any green-yellow wire).

CAUTION: This test should only be done by an experienced person familiar with electricity and its dangers.

Bad Power Relay

1) You should be able to hear the relay going on and off with a soft clicking noise when you first turn on the kiln and it is supposed to be heating up. If not try turning the kiln off and then back on again and restarting the program. Of course if you don't hear the relay it only tells you that it isn't firing. The problem could be in the control for instance not telling the relay to fire. If you do hear the relay and the kiln is not heating then you know the problem is in the power circuit AFTER the relays.

TROUBLESHOOTING & FIXING THE FUEGO OR ROBIN KILN (EUROPEAN VERSION)

2) Check output from Power Relay . With panel of kiln and panel plugged in and firing check the output of the Power Relay . You should see 220 to 240 volts at the output when the relay is engaged. **CAUTION: This test should only be done by an experienced person familiar with electricity and its dangers.**

Checking output of relay:



Bad Elements

See next section.

KILN FIRES UNEVENLY

Peepholes

1) Plug up Peephole and vent holes in the kiln to prevent drafts.

Lid Seal

1) Check to make sure that door/lid is sealing properly. If door/lid is not sealing against top brick correctly a bright red glow will be visible around the door/lid seal when kiln is operating. (A little of this is OK). Also excessive heat loss can be felt around seal. Rub seal high points down with sandpaper until no more than 1.5mm (1/16") gap is found at any point along seal. Note that the gap at the top will definitely appear larger than any gap you see between the kiln sections. This is partly because the lid actually bows down in the center of the lid when it heats up and the edges consequently rise slightly . Just check for an UNEVENNESS in this gap which will cause an excessive heat loss.

2) If door/lid is excessively cracked or worn or has holes in it this may cause drafts in the kiln. Replace lid.

This shows a crack in a lid that is OK. Cracks are a natural event with refractory slabs. As long as the crack does not create a large pathway for heat to escape and remains stable it is OK to leave as it. See the section in the back called CRACKS IN THE TOP & BOTTOM:



Elements

1) Elements may have differentially changed in resistance. Check element resistance (see section at end of Troubleshooting Guide called "CHECKING ELEMENT OHMS").

2) Empty the kiln. Then turn kiln on using a fast program like F AST GLAZE (USr3) until elements are red. Open the door carefully and observe the elements to see if they all seem to be glowing about the same amount.

Loading

1) If you are having a problem with uneven firing try to vary the way you load it to match the firing characteristics of the kiln. For instance if it typically fires hot at the top then put more weight in the top to absorb that heat.

2) Be sure to put at posts under the bottom batt. The bottom batt should be at least 1.25cm to 2.5cm (1/2" to 1") above the floor of the kiln.

Firing with Cones

1) Try using cone packs in all sections (top, center , bottom) of the kiln and keep records of what happens. See next section.

TROUBLESHOOTING & FIXING THE FUEGO OR ROBIN KILN (EUROPEAN VERSION)

KILN FIRES TOO HOT OR COLD

Firing with Cones

1) On the next firing make up 'cone packs', one for each thermocouple. A cone pack is a set of three cones, standing in a line. The target cone is the cone number you are firing to and is in the middle. The one in front of it is one cone number lower, and the one behind it is one cone number higher. Use Large Self-Supporting Cones. You can purchase these through your ceramic supply distributor. They come 25 cones per box and are quite inexpensive.

2) Once the cone packs are positioned on shelves and are visible through the peepholes, fire the kiln to the middle cone's number.

3) Near the end of the firing start watching the cone packs. Look for the first cone to fall over in each pack, not necessarily at the same time, but pretty close, probably in the middle zone first. (NOTE: See the chart for cone temperatures in the programming section of the Operation Instructions).

Picture of a "cone pack" (Courtesy of Orton). The ones in the back are before the firing and the ones in the front are after a perfect firing. These are Self-Supporting Large Cones.



CAUTION - USE SAFETY GLASSES

USE DARK SAFETY GLASSES (#3 LENSE COLOR) WHEN VIEWING INTO THE KILN. The infrared heat of the kiln could damage your eyes and ceramic work can explode and send sharp glass-like objects into your eyes. See the Parts List for details on ordering..

4) Now watch for the middle cone in each pack. Keep checking the control display to be sure it does not say

CPLt. The middle cone in each pack should start to fall at pretty much the same time in the top, middle and bottom of the kiln. When the tip of the cone bends about half way down note the temperature readout on the display for that zone's thermocouple.

a) If the middle cones did not go down together then immediately note the differences in each TC reading from the one TC in the same zone as the first cone that went down. Change the final set point of your program to reflect the difference. If the kiln is firing too hot then simply lower the final set point.

TIP: Be sure to run any tests with a dummy load as close to the loads you run. Kilns fire differently with loads.

b) If the kiln shut itself off before bending the cones properly, you want to reprogram it and then re-start it as quickly as possible. Note the temperature at which the kiln shut down. Stop and restart kiln. Re-program the same program to one cone number higher. Do these steps quickly. Now watch the middle cones again and note at what temperature the cones properly bend. If they bent while you were programming then just offset the temperature by 5 or 6 degrees. Shut the kiln off once you note that temperature.

NOTE: See ortonceramic.com for lots of very helpful information on how to use cones and for many firing tips and great information on firing kilns. Also see the tabbed section in your instruction manual called ORTON TIPS.

Hold Times

Be very careful with hold times. Even a fairly short hold time of 10 minutes can dramatically increase the amount of heat work and hence the cone that the kiln fires to. On the other hand you can use the hold time to increase the heat-work to compensate for under-fired work. Just test this in small increments. There is a great program available for free from Orton's web site that allows you to calculate this with some precision.

Thermocouple Drift

Thermocouples drift in their accuracy with time. You may have to make further adjustments in the final set point temperatures that you fire to over time.

TROUBLESHOOTING & FIXING THE FUEGO OR ROBIN KILN (EUROPEAN VERSION)

KILN STALLS

1) If for some reason the thermocouple wire touches the hot kiln case they may melt and fail. The result of this is that the kiln can “stall out”, say **CPLt** prematurely or display any other number of other random error codes. It may refuse to increase in temperature, and the kiln will just run on and on. If it is re-started it may work fine for a while. What happens is that the millivolt signal in the TC wire goes to ground, or the two wires in the TC wire are 'electrically' connected by the stainless steel melting through the insulation and the 'temperature' is then taken right there, not in the kiln. However, the signal received can be so foreign to the microprocessor that the kiln will just stall. The Thermocouple Lead Wire needs to be replaced.

2) Thermocouples close to end of their useful life can cause some of these same problems.

3) Sometimes excessive ambient temperatures (over 50°C / 125°F) around the control can cause stalling too.

4) Corroded connection points can also cause stalling.

KILN FIRES SLOWLY

Bad or Wrong Voltage

1) Check your voltage. Do this at the receptical or at your fused disconnect box. **CAUTION: This test should only be done by an experienced person familiar with electricity and its dangers. You need to see what the voltage is when the kiln is firing.**

Low voltage will make the kiln fire considerably slower. Check voltage at your panel and where the kiln is connected. Check the voltage when the kiln is firing and when it is not firing. Sometimes the high amperage draw of the kiln will cause a voltage drop at the kiln. A voltage drop of 5 to 10 volts is not uncommon and is to be expected. If your voltage drop is more than that then you may have a problem with your electrical supply.

2) Make sure no other large electrical appliances such as a clothes dryer or electric oven are on when you are operating your kiln. This may cause a voltage drop which would slow the kiln down.

3) Voltage may vary in your area depending on season and time of day. Frequently there are "brown outs" during the summer months in some areas. This is when the electric utility reduces the voltage. Try firing at night after peak electrical use hours. You can use your Delay feature to do this easily. Find out from your local utility company when the end of the peak period of electrical use is. Some utilities offer preferential rates for using electricity at night because it is cheaper for them.

4) Check to see what the wire size of your circuit is. If it is very long (more than 50 feet) from your main circuit box then the wire size might need to be higher (#8 instead of #10 wire).

Element Aging

1) Elements age when fired and the elements increase in resistance. When they increase in resistance the amount of power they develop decreases. See the section on “CHECKING ELEMENT RESISTANCE” at end of this guide.

2) Replacing only one element may cause an unbalance in firing.

3) Empty the kiln. Then turn kiln on until elements are red. Open the door carefully and observe the elements to see if they all seem to be glowing about the same amount.

4) Elements expand and grow with age. If you fire low-fire clay and glazes and never get above cone 05 or so, your elements will last a long time, especially if you are only bisque firing. This is good, to a point. If you only low-fire, the problem you are most likely to encounter over many years is that the elements will expand as they age. The length and the coil diameter increase. Meanwhile the atmosphere in the kiln slowly eats away at the metal of the element.

Although the total resistance usually increases as the elements age, sometimes it decreases, or reverses itself. This usually only happens when the elements are very old but have not yet failed completely. As the element expands, it binds up in the corners. This can make the individual coils push together and touch each other in the corners, making a short cut for the electricity, reducing the amount of element material the electricity must pass through, and therefore

TROUBLESHOOTING & FIXING THE FUEGO OR ROBIN KILN (EUROPEAN VERSION)

reducing the resistance in the whole element. This may make it hotter in the kiln, but if there is a lot of element material jammed in the corners there will not be enough material left in the coiled form to radiate the heat generated by the increased amperage and decreased resistance. Only the parts of the wire not touching the coils on either side of them will emit heat. More amperage through the electrical components in the control could cause damage if the situation continues or the resistance drops far enough. In addition, the expanding diameter of an element can make it difficult to get it out of the holder. Usually this will not happen to those firing to higher temperatures because the maximum temperature of the kiln is quickly compromised by increases in the resistance, requiring the elements to be changed long before they can jam up in the corners. Also, high temperatures and glaze firings are more prone to eating through the element, causing it to fail, before the element can expand enough to cause the problems mentioned above. Visually inspect your elements for the above conditions and do a resistance check. If you see this it may be time to change elements.

Power Relays

1) Power Relays may cause poor transfer of power to elements when they have been used for a long period of time. It is not always a total failure - which is of course harder to troubleshoot. If this is suspected replace the relay.

Bad Wiring

WIRES WILL GET HOT

Unlike many other appliances that use electricity (like motors) kilns are called a "resistive load." This means that there will be a continuous pull of steady electrical power for many hours. Even with properly sized wire this will generate SOME heat in the wires. If you look carefully you will see that we have **OVERSIZED** our internal power wires far in excess of their rated capacity. In addition all our power wire is rated for very high temperatures. The larger the wires the less resistance in the wires and the cooler they will operate.

1) Have an electrician check your wiring. We have seen aluminum wire cause intermittent problems with allowing enough voltage through. We do not recommend aluminum wiring. The problem with it is that aluminum oxide, which is formed from heat, is a resistor while copper oxide is not a resistor. With kilns you will often develop some heat in the electrical lines. If all connections are perfect and the wire is oversized you probably will not have a problem - but why take that chance? Make sure your wires are of the proper size and that all connections are good.

2) Check your circuit breaker for proper operation. These sometimes go bad over time.

3) If all the elements are firing and the kiln is still firing too slow check the amperage draw of the kiln under a full load. you should read around 13 amps. **CAUTION: This test should only be done by an experienced person familiar with electricity and its dangers. You need to see what the voltage is when the kiln is firing.**

Check amperage under load with an amp-probe as shown. You need to hinge open the panel and put an amp probe clamp around one of the Element Connection Wires:



TROUBLESHOOTING & FIXING THE FUEGO OR ROBIN KILN (EUROPEAN VERSION)

Wiring in the Kiln

- 1) Unplug kiln.
- 2) Trace wiring for missing or bad connections.
- 3) Check wiring against wiring diagram.
- 4) Check for corroded connectors or connectors that have frayed wires. Replace if you see this.

Element Connections

- 1) The holes where the elements go through the firebrick walls are too large. This could cause too much heat to escape from the kiln thereby overheating the element terminals. This can be remedied by lightly stuffing non-RCF ceramic fiber in the element holes. (See the Parts List for non-RCF fiber). You can stuff this in from the inside of the kiln using a sharp tool like a very small screw driver.
- 2) Check to see if the element ends are twisted properly. They should be twisted clockwise around the terminal screw. If the twist is too loose this could generate extra heat at the element ends. Check for corrosion on the terminal. If there is corrosion sometimes you can remove it with a wire brush.

Photo of element terminal with element end twisted around it properly:



- 3) The element connection hardware may not be tight enough. A loose connection can generate heat and cause oxidation of the hardware which in turn will cause a worse electrical connection (because of resistance) and more heat. Replace with new hardware.

Heat Leakage & Vents

- 1) Make sure peephole and vent plugs are in.

- 2) If your lid or bottom is cracked check to see if it seems to be leaking much heat at high temperatures. Patch or replace if extreme. (SOME IS OK).

Adding More Insulation

- 1) In L&L's top loading kilns an additional bottom may be placed under the original bottom. This will improve the insulation in the kiln, thereby slowing heat loss and speeding the firing time. You can also put a 2" layer of calcium silicate on top of the stand beneath the bottom of the kiln.
- 2) Also try raising the height of the kiln from the floor or **putting a reflective stainless steel or aluminum sheet under the kiln**. All these things keep the floor from absorbing the radiant energy from the kiln and will improve heat up times (as well as bottom of the kiln uniformity).
- 3) Put a 1" layer of non-RCF ceramic fiber on the lid. This is non-hazardous which is important in this application because you will be releasing fibers into the air when you move it while loading. While this is a somewhat extreme measure we have found that a disproportionate amount of the heat loss from a kiln is through the top. Non-RCF ceramic fiber is soluble in the body and is considered totally safe. (See the Parts List).
- 4) **Whatever you do be sure NOT to put the kiln directly on the floor. If the floor is cement or other hard non-flammable material it will absorb the heat from the kiln. If the floor is wood or other flammable material you will create a very DANGEROUS situation which could cause a serious fire.**

TROUBLESHOOTING & FIXING THE FUEGO OR ROBIN KILN (EUROPEAN VERSION)

KILN HEATS TOO FAST

Voltage

1) Check your voltage. Some people may have high voltage like 245 volts where you should nominally have 220 to 240 volts.

Elements

1) Check element ohms and compare with factory values. (See CHECKING ELEMENT OHMS).

2) Make sure the elements are wired properly. **Check the wiring diagram.** IF THE ELEMENTS ARE WIRED IN PARALLEL RATHER THAN SERIES THE KILN WILL OVERHEAT QUICKLY.

ERROR MESSAGES

Error codes can appear at any time during the firing. They always refer to a problem that, if allowed to continue, could end with unknown or even disastrous results. **Errd**, **Err1**, **ErrP** and the **FAIL** message make the most frequent appearances.

Errd

Error d indicates that the kiln temperature is 60°C (100°F) above the traveling set-point, which is the current desired temperature in the kiln. The traveling set-point will increase or decrease according to the programmed rate.

- 1) Something is too close to, or is touching the thermocouple. Allow almost an inch between everything for thermal expansion. Adjust load and re-fire the kiln.
- 2) The Thermocouple Lead Wire has melted against the kiln case. The wire must be replaced.
- 3) The thermocouple is about to fail. Perform a physical inspection, or just re-start the kiln and monitor it carefully.
- 4) Element(s) just burned out. Perform an ohms test for more information.
- 5) The relay has just failed.
- 6) There is a bad connection point somewhere. This will become more of a possibility as the kiln ages.

Examine all points carefully for melting, corrosion, discoloration and/or bad electrical smell.

Err1

Error 1 indicates the temperature in the kiln is rising during an up ramp slower than 3°C/hour. If this rate continues for 20 minutes the firing will be stopped.

Err1 may be an indication that the elements are worn or that a relay has stopped working.

1) If **Err1** is the error code on the screen when you check on the firing, then for some reason the kiln could not generate enough heat to counter the heat loss. If the kiln can get no hotter (even though all the elements appear to be on and the program is not holding), then **Err1** is what you will see. **Err1** can mean either you need new elements or a new relay. An ohms test and a voltage test can tell you which it is. If you recently changed locations, power supplies, elements, or did any repairs, then closely examine what changed between your last successful firing and this one. There may be some other issue besides bad elements or a bad component.

2) In re-wiring the power supply you may not have used thick enough copper wire (line, conduit and connection points will be very hot).

3) The elements are the wrong resistance. Check new elements with your multimeter just to be safe. Mistakes can happen.

4) If you rewire anything improperly or incorrectly the potential for anything from a blown breaker to just no power at all is possible. (Using wire with a temperature rating of less than 150°C for the power wiring can seriously limit the life of the circuitry and can be dangerous as well, especially when the wires are close to the kiln. Use a wire diagram and trace every wire to check yourself).

ErrP

Error P is displayed whenever there is a power interruption that is long enough to stop the firing. If the power interruption is brief the kiln will continue to fire when power is restored; in this case there will be no indication of a power failure. To clear the error, press any key.

TROUBLESHOOTING & FIXING THE FUEGO OR ROBIN KILN (EUROPEAN VERSION)

This error can also happen as a result of RF noise that resets the microprocessor. If this is suspected, the control panel should be returned to L&L for testing and possible modification.

ErrF

Error F indicates the temperature in the kiln is decreasing during a down ramp less than 8°C (15°F)/hour. If this rate continues for 8 minutes the firing will be stopped. **ErrF** may be an indication that a relay has stuck in the on position.

tC-

Error tC- indicates that the white and green thermocouple wires are reversed. Make sure they are right all the way through the circuit. White is positive. Green is negative.

FAIL

See the section in these Troubleshooting Instructions called **DISPLAY READS FAIL and tC**.

Can you restart the kiln after it stops because of Error Codes?

You can try to restart the kiln after getting an error code. Some messages, like flashing **ErrP** and **FAIL**, will not necessarily turn off the kiln. Depending on the problem though, re-starting it may or may not let it finish the firing, or even start up again. An **Err1** at the end of the firing will re-start but will probably re-occur in about 22 minutes.

Worst Case Scenario for Restarting After an Error Code

Keep in mind that you run the risk of over-firing if you re-start while the kiln is very close to the final temperature. A pyrometric cone melts with the proper combination of time and temperature. Add more time and you don't need as high a temperature, go to a higher temperature and you don't need as much time. When an error code shuts down the kiln near your final temperature (within about 50 degrees) and you do not know exactly how long it has been cooling, or what temperature it reached before the error code appeared, you run the risk of having too much unaccounted for time in your time-temperature equation.

If you have cones in the kiln that you can see through the peepholes, then use these after you re-start and turn off the kiln manually when the target cone bends over.

If you do not have cones visible then you can gamble and estimate a final temperature based on how many degrees per hour the kiln has risen, including the time it was off.

In reality, however, an **Err1** that close to the end of a firing probably means you need new elements. So re-starting the kiln will probably not enable it to climb much higher in temperature. Keeping track of the time, let it run, and when it shows **Err1** again just keep re-starting it until the firing finishes. Meanwhile call and order new elements.

In general though, Error Codes mostly appear after the kiln has been disassembled and set back up improperly, has had its power supply altered (like moving to a new studio with different voltage), or has had an element or a thermocouple burn out.

REMOVING PANEL FOR SERVICE

1) It is easy to access the inside of the control panel for troubleshooting. In addition it is easy to remove this panel and send it back to the factory for inspection and/or repair.

2) Unplug the kiln.

3) Follow the instructions in the Assembly Instructions for removing the Control Box.

4) Pack the control panel with cushioning material such as bubble wrap, balled-up newspaper or foam in a cardboard box and follow instructions from your local distributor about where to send it. **DO NOT SEND A CONTROL PANEL WITHOUT CALLING FIRST.**

CAUTION: The controller contains electronic components which are sensitive to static electricity. Before handling the controller dissipate any static charge you may have by touching metal on the kiln or some other grounded object.

TROUBLESHOOTING & FIXING THE FUEGO OR ROBIN KILN (EUROPEAN VERSION)

REPLACING CONTROL

- 1) Unplug kiln.
- 2) Remove the four small screws that hold the control in place from the front face of the control panel.
- 3) Remove the control box and remove the insulation panel.
- 4) Pull off the spade connectors from all the connection points on the back of the control. Loosen the screws that hold down the thermocouple wires and pull out the wires from under the screw heads. It is OK to remove the screws if this is easier for you. First note where all the wires go. These are all clearly marked with color coding on the Wiring Diagram.
- 5) Pull old control out. Put new control in and screw in place with the small mounting screws. Replace wires on proper connectors.
- 6) Be careful to get the white TC wire on the negative terminal and the green TC wire on the positive terminal on the control board. NOTE: The terminals on the control are painted RED for negative and YELLOW for positive.
- 7) Double check that the proper color coded wire goes to the proper terminal:

Orange = OUT, Gray = AC1, Green-Yellow = CT,
Black = AC2

REPLACING TRANSFORMER

- 1) Unplug kiln.
- 3) Remove the control box and remove the insulation panel.
- 3) Using needle nose pliers pull off the wires from the transformer. THIS CAN BE TRICKY. It can take a good bit of force sometimes to remove these little spade connectors. You will probably not be able to do it with just your hands. Also the spade connectors on the transformer are not very strong. Take your time. Of course, if you are replacing a bad transformer it doesn't matter if you damage it.

Picture showing wires being pulled off the control transformer.

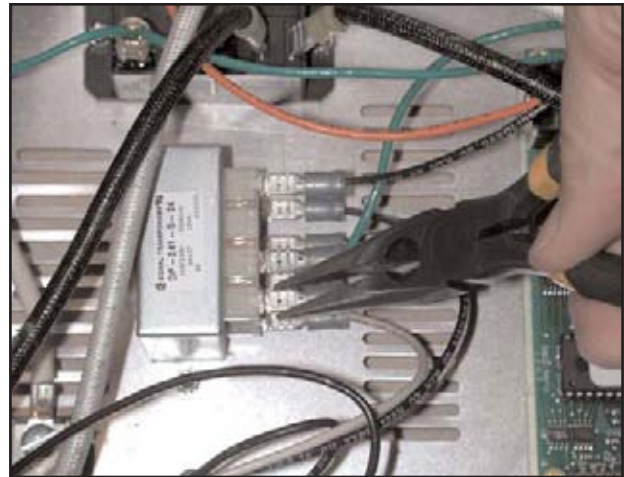

- 4) Unscrew the two nuts that hold the control transformer onto the panel and remove the transformer.
- 5) Before installing the new transformer put the small jumper wire onto terminals #2 and #3 on the bottom row of terminals. Note the little numbers by the contacts.

REPLACING POWER RELAY

- 1) Unplug kiln.
- 2) Remove the control box and remove the insulation panel.
- 3) Pull off the wires to the relay. Everything is color coded and marked so you can refer to the wiring diagram when replacing if you forget where the wires go.
- 4) Remove the nuts from the studs that hold the relay in place. Remove old relay and replace with new one.
- 5) Visually inspect the wire connectors. Do they look corroded or "cooked"? Are the wires frayed? Any corrosion on the wire itself? If any of this is questionable you should replace the appropriate wires.
- 6) Reconnect all wires. Visually inspect to make sure the spade connectors are down as far as they can go and feel to see that they are tight (a gentle tug should not remove one). If they are loose for some reason remove the wire and slightly squeeze the spade connector with pliers to tighten it.

TROUBLESHOOTING & FIXING THE FUEGO OR ROBIN KILN (EUROPEAN VERSION)

IMPORTANT: The slip on wire connectors can not be loose or corroded. If there is a bad connection then heat will be generated and the component that they slip onto (relay , terminal strip, etc) may overheat and fail. If you squeeze the slip on terminal to make it tighter - be sure to squeeze it evenly so that one side is not tight and the other loose. If there are any doubts about the integrity of the wire or the connector replace the whole wire or harness.

REPLACING FUSE HOLDER

- 1) Unplug kiln.
- 2) Remove the control box and remove the insulation panel.
- 3) Remove the wire connectors from the end of the fuse holder on the inside of the panel.
- 4) Unscrew the nut that holds the fuse holder in place.
- 5) Remove and replace with a new fuse holder
Reconnect wires.

REPLACING THERMOCOUPLES

- 1) Unplug kiln.
- 2) Remove or hinge open the control box.
- 3) Remove the Thermocouple Lead Wire from the Thermocouple.
- 4) Unscrew the Thermocouple from the kiln (these are #6 x 1-1/2" screws)
- 5) Remove Thermocouple.
- 6) Install a new Thermocouple and screw in place.
- 7) Replace Thermocouple Lead Wire and tighten. Be sure to get Green Wire matched to the Plus sign and the White Wire matched to the Minus sign.

NOTE: The terminals on the control are painted RED for negative and YELLOW for positive.

Tighten screws on thermocouple lead wire:

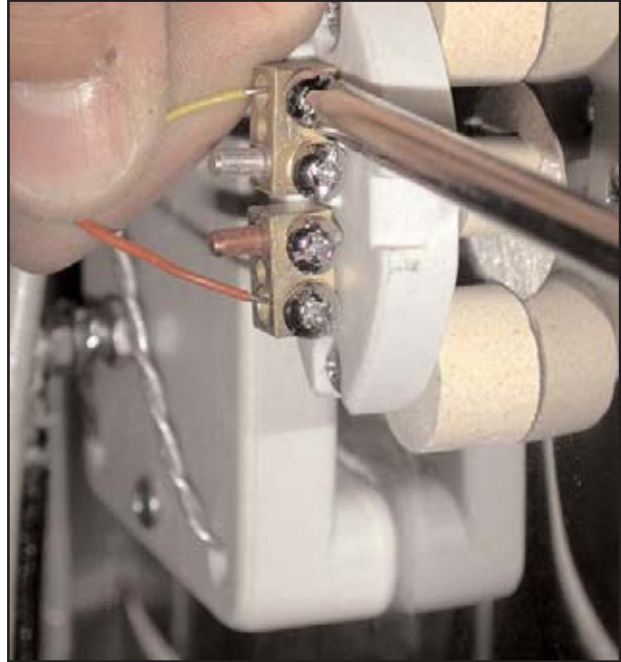

REPLACING ELEMENTS

- 1) Unplug kiln.
- 2) Remove the Control Box.
- 3) Using a 10mm (3/8") nut driver , ratchet wrench or adjustable wrench remove the nuts that hold the element end onto the Element Terminal Bolt. Note that the terminal bolt head is head firmly in place by an inset shape on the underside of the ceramic terminal block and it will not turn much.
- 4) Untwist the element end from around the Element Terminal Bolt. Straighten it out as much as possible.

TROUBLESHOOTING & FIXING THE FUEGO OR ROBIN KILN (EUROPEAN VERSION)

Untightening the element terminal:



Using a sharp tool like a screw driver lift the elements out of the ceramic grooves at the corners. You can slide the holder over to make enough of a gap to get the tool under the element:



5) In most cases you can just lift the element out of the holder at this point. Sometimes, if the element has really disintegrated, you need to remove it in pieces with needle nose pliers.

Lift Elements out of the groove of the ceramic holders:



6) If element is hard to get out of the holders (because of growth of the element) you can try heating up the

kiln slightly so as to heat up the element slightly to just the point where element is slightly pliable - don't let it get red. This will soften the wire. Then turn off the kiln and disconnect all power to the kiln. Then, using heat protecting gloves (such as welding gloves or the gloves that you can buy from our Parts List) and a pair of needle nose pliers pull out the softened element. **IF YOU DECIDE TO USE THIS METHOD BE VERY CAREFUL OF THE POTENTIAL FOR BURNING YOURSELF.**

7) From the inside of the kiln, using needle nose pliers, grab the element as close to where it goes through the brick wall to the Terminal Block. Pull the element end through the hole. Be careful not to enlarge the hole in the firebrick. The brick is quite soft and will not take much abrasion.

Removing element from inside the kiln:



8) Be sure to check for failure points for evidence of contamination on the element and the element holder. If the element holder is contaminated it will cause rapid failure of the new element. Replace contaminated holders with new ones.

9) Using your multimeter check the resistance of your new element. Check it against the chart at the back of this Troubleshooting Guide.

TROUBLESHOOTING & FIXING THE FUEGO OR ROBIN KILN (EUROPEAN VERSION)

Checking resistance of the elements before you put them in. This is a good double-check and can save you a lot of trouble if there is a mistake. Put the probes on the twisted element ends about 3" from the beginning of the coil:



10) Install the twisted ends of the elements through the holes in the wall of the kiln. Element ends should be straight at this point.

11) Pull them up tight up to the wall of the kiln by pulling from outside the kiln.

12. Lay the element into the groove. Note that the unfired element is going to have some springiness to it before it is fired for the first time. You may need to use a screw drive to press the element into the holder.

YOU DO NOT NEED PINS.

13) Install the elements and hardware.

Detail showing how all the hardware gets assembled on the Terminal Bolt. The hardware has not been tightened yet.:



Photo of element terminals with elements and jumper wires and power lead wires shown:

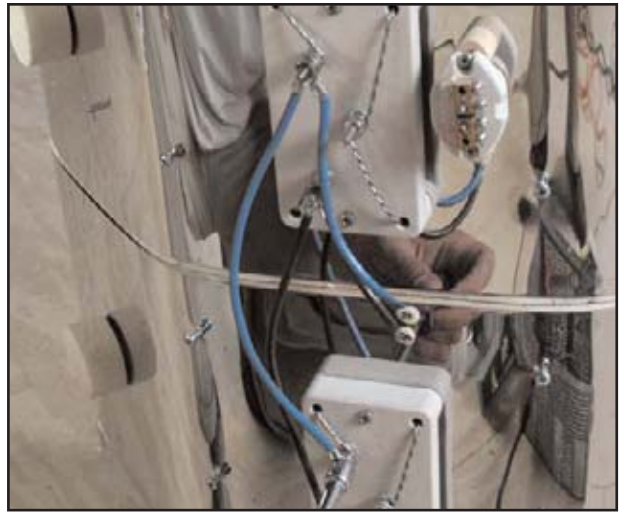

REPLACING ELEMENT HOLDERS

1) When ordering a new holder provide model number of kiln and length of the element holder . See the Parts List for this information.

2) Note that if the holder has melted badly you may need to either replace the brick that holds it or at least patch the brick with our Brick Repair Kit.

Method #1

1) This method leaves the kiln in tact. You break up the holder and remove it in pieces and then modify the new holder to snap into the groove.

2) Using a chisel or large screw driver and a hammer carefully crack the holder that needs to be removed.

Just take your time with this. You can break the holder into little pieces so that it comes out:



TROUBLESHOOTING & FIXING THE FUEGO OR ROBIN KILN (EUROPEAN VERSION)

The holder shown with about half the job done:



The groove is shown with the holder removed:



*Using Linemen's Pliers snap off the **BOTTOM** edge of the holder (note carefully the fact that the **BOTTOM** of the groove is closest to the edge that you are breaking off.):*



A normal holder compared to one with edge removed:



You can now just snap the new holder into the slot in the firebrick. It will hold in place with no cement:



Method #2

This method requires you to take the kiln sections apart.

- 1) Take the section with the bad holder of the kiln and put it on a flat surface like a flat floor or table.
- 2) Carefully pull the elements out of the element holders of the brick section involved and allow them to hang loose. Take great care not to "break" the element as they are very brittle after firing.
- 4) Loosen up the adjustable clamps that hold the stainless steel wrapping. Loosen them just enough to allow the brick to slide out with slight hand pressure (so that the other bricks stay in place). NOTE: If you don't have the section on a flat surface then the bricks will all come out of proper alignment at this point.
- 5) Pull up the brick with the bad element holder just enough to allow removal of the defective element holder and replace with new one. Slide the bad

TROUBLESHOOTING & FIXING THE FUEGO OR ROBIN KILN (EUROPEAN VERSION)

brick(s) out and put in new brick(s). Be sure the element holders line up with the other holders on either side. Note there is a top and a bottom in the element holder so be sure to get the orientation correct.

6) Retighten the clamps on the wrap. Alternately tighten the bottom and top clamp so that you don't cock the stainless casing.

CRACKS IN THE LID & BOTTOM

1) It is quite normal to get hairline cracks in both the lid and the bottom firebricks.

2) They are caused by the expansion and contraction of the firebrick as it heats and cools.

3) As long as the bottom is fully supported by the stand the cracks in the bottom will not adversely affect the operation of the kiln.

4) The stainless steel clips we use in our lids also help keep these natural cracks from normally becoming a problem.

5) Note that it is possible to put another bottom under the original bottom as a second layer (this can also improve performance and heat up rate of the kiln).

6) It generally does not make sense to cement these hairline cracks.

7) You can tighten the stainless steel band.

This crack is OK:



TIGHTENING STAINLESS BANDS

1) The brick will shrink slightly over time. This is more pronounced when using the kiln at higher temperatures like cone 10.

2) If the bricks shrink too much they will become loose.

3) Tighten the case by turning the screws of the case clamps. Do this 1/4 of a turn at a time on each of the clamps. Keep a balanced tightening (i.e don't tighten one clamp too much at one time). Slow is good.

Tightening the bands:



4) You can do this on the bands around the top and bottom also. This will help maintain the integrity of those slabs even if there is a crack.

REPLACING FIREBRICK IN SIDES

1) If you need to replace a firebrick piece in one of the sections do the following. While it does not require a great deal of experience to accomplish it does take time and patience.

2) Order the firebrick precut and prerouted from L&L Kiln. You can order this with the proper element holders already in place or you can reuse the holders from your old brick. Be sure to order it for your specific model kiln. Also, be sure to say whether it is a brick where the element connections come through (because this has different element holders. There are no holes drilled in the brick for either peepholes or element connections. This has to be done in the field.

TROUBLESHOOTING & FIXING THE FUEGO OR ROBIN KILN (EUROPEAN VERSION)

3) Take the section of f the kiln and put it on a flat surface like a flat floor or table. Elements will have to be removed and probably replaced.

4) Loosen up the adjustable clamps that hold the stainless steel wrapping. Loosen them just enough to allow the brick to slide out with slight hand pressure (so that the other bricks stay in place). NOTE: If you don't have the section on a flat surface then the bricks will all come out of proper alignment at this point.

5) Slide the bad brick(s) out and put in new brick(s). Be sure the element holders line up with the other holders on either side. Note there is a top and a bottom in the element holder so be sure to get the orientation correct.

6) Retighten the clamps on the wrap. Alternately tighten the bottom and top clamp so that you don't cock the stainless casing.

7) Sand off the top surface of the firebrick to match the surface of the other firebricks. Sandpaper will work fine. Reface with facing (See Parts List).

DRILLING OUT HOLES FOR PEEPHOLES

1) Some of the bricks that you may need to replace will need to have holes drilled in them in the field. These holes can not be drilled in the factory because the alignment would not be perfect.

2) To drill out for peepholes use a 1" diameter drill bit or hole saw. You can also drill with a smaller drill and then file out with a round hasp type file. In all cases the peephole can be drilled perpendicular to the stainless case. You may have to remove the bit several times and clean it out as you drill deeper. It is a good idea to have someone help you by watching from the side to make you you are keeping the drill perpendicular.

3) Drill slowly through the firebrick using the prepunched hole in the stainless steel.

Drilling the peephole:



4) Before drilling, as a precaution, you can measure down from the top of the brick to the top of the existing hole in the stainless steel case. This measurement on the inside will show you where the top of the drill bit will protrude. Adjust your angle of drilling accordingly.

DRILLING OUT FOR THE ELEMENT CONNECTIONS

1) Use a 3 to 5mm (approx. 1/8" to 3/16") diameter drill bit and drill out from the center of the hole in the stainless steel case. Do this slowly with a speed control.

2) Do this perpendicular to the case.

REPLACING BOTTOMS

1) Remove the kiln sections.

2) Take the old bottom off the stand.

3) Put the new bottom on the stand.

4) Relevel the kiln.

5) Replace the kiln sections.

NOTE: You may want to experiment with using it as a secondary back up bottom if it is not too badly damaged. Some people find that having this extra insulation thickness helps firing times and bottom uniformity).

TROUBLESHOOTING & FIXING THE FUEGO OR ROBIN KILN (EUROPEAN VERSION)

REPLACING LIDS

- 1) Remove one of the Cotter pins from the Hinge Bar.
- 2) Pull out the Hinge Bar.
- 3) Unscrew the chains from the stainless steel case of the lid.
- 4) Remove the Top Hinge Part from the old lid.
- 5) Using the old top as a guide, install the Top Hinge Part onto the new lid.
- 4) Reinstall the top.

CHECKING ELEMENT OHMS

- 1) The following chart gives you the ohm ratings for both the individual elements and the ohm ratings for the element circuits.
- 2) It is very easy to check the element circuit ohms.
- 3) Unplug kiln.
- 4) Remove the Control Box. See the Assembly Instructions if you need help with this.
- 6) Using your Multimeter set on Resistance or Ohms check resistance across the two main Power Lead Wires.

Checking Circuit Ohms for the whole kiln. All wires stay connected while you do this. Kiln is UNPLUGGED:



- 7) If you check the resistance at this point the values you should get are as follows: 15.8 ohms

- 8) The values should be within 6% to 12% of the listed values. Typically the resistance increases over time and use and this makes the power generated by the elements decrease. Depending on the temperature you are firing to you may get away with a wider variation.

- 9) If you want to test each section then remove the jumper wires between the sections and test as shown. the resistance values should be as follows for each separate section: 31.6 ohms

Checking Circuit Ohms for each section:



- 10) In addition here are the values for the individual elements: 15.8 ohms

We give values for individual elements so that you can check specific element resistance before you put elements in or if you want to isolate the elements.

Checking Circuit Ohms for one element:



FOR PARTS AND SERVICE CONTACT POTCLAYS LTD

Potclays Ltd

**Brickkiln Lane, Etruria
Stoke-on-Trent
Staffordshire ST4 7BP**

Phone: 01782 219816

Fax: 01782 286506

Email: sales@potclays.co.uk

Web: www.potclays.co.uk





© 2004 by L&L Kiln Mfg., Inc.

L&L Kilns are imported into the United Kingdom by Potclays LTD